

Beginners' Guide: Getting Started with FEA



LISA Finite Element Analysis

Software Version 8.0.0

2013

Contents

Chapter 1

Welcome to FEA 4

1.1 [Simple overview of the Finite Element Method](#), 4

1.2 [Basic operations in the graphics area](#), 6

1.2.1 [Basic graphics tutorial](#), 6

1.2.2 [Solution tutorial](#), 10

Chapter 2

Modeling 12

2.1 [The finite element model](#), 12

2.2 [Manual meshing](#), 13

2.2.1 [T-shaped beam tutorial](#), 13

2.3 [Creating](#), 19

2.3.1 [Quick element](#), 19

2.3.2 [New node and new element](#), 19

2.3.3 [Insert node between](#), 19

2.3.4 [Templates](#), 20

2.3.5 [Curve generator](#), 20

2.3.6 [Polyline](#), 21

2.3.7 [Automesh 2D](#), 22

2.3.8 [Plates](#), 23

2.4 [Editing](#), 24

2.4.1 [Move](#), 24

2.4.2 [Rotate](#), 24

2.4.3 [Mirror](#), 24

2.4.4 [Scale](#), 24

2.4.5 [Hollow](#), 25

2.4.6 [Fit to sphere/cylinder/cone](#), 25

2.4.7 [Merge nearby nodes](#), 25

2.4.8 [Delete unused nodes](#), 25

2.4.9 [Invert](#), 26

- 2.5 [Converting a two dimensional mesh into a three dimensional mesh](#), 26
 - 2.5.1 [Extrude](#), 26
 - 2.5.2 [Revolve](#), 26
 - 2.5.3 [Loft](#), 26
- 2.6 [Refinement](#), 27
 - 2.6.1 [Refine x2](#), 27
 - 2.6.2 [Refine Custom](#), 27
 - 2.6.3 [Quad local refinement x2](#), 28
 - 2.6.4 [Quad local refinement x3](#), 28
 - 2.6.5 [Change element shape](#), 28

Chapter 3

Analysis Types

30

- 3.1 [Static analysis of a pressurized cylinder](#), 32
- 3.2 [Thermal analysis of a plate being cooled](#), 37
- 3.3 [Modal vibration of a cantilever beam](#), 42
- 3.4 [Dynamic response of a crane frame](#), 46
- 3.5 [Magnetostatic analysis of a current carrying wire](#), 50
- 3.6 [DC circuit analysis](#), 53
- 3.7 [Electrostatic analysis of a capacitor](#), 56
- 3.8 [Acoustic analysis of an organ pipe](#), 60
- 3.9 [Buckling of a column](#), 76
- 3.10 [Fluid flow around a cylinder](#), 79

Chapter 4

Modeling Tutorials

83

- 4.1 [Tapers, rectangle and V shaped cut-outs](#), 83
- 4.2 [Rib, counter-bore and rounds](#), 91
- 4.3 [Intersecting holes and polygon shapes](#), 112

Welcome to FEA

This guide assumes that you are new to LISA and indeed may be new to finite element analysis. Here you will find a simple account to give you the overall picture and get you started using the program. Once you have learned the basic concepts and operations, you will be ready to advance your skills with the more sophisticated features described in the companion '*Tutorials and Reference Guide*'.

1.1 Simple overview of the Finite Element Method

Suppose you want to solve a physical problem such as finding the stresses in an object when some prescribed forces are applied. This is a typical problem for FEA: some type of 'force' is applied to an object and the response calculated subject to specified constraints. This is the usual structure:

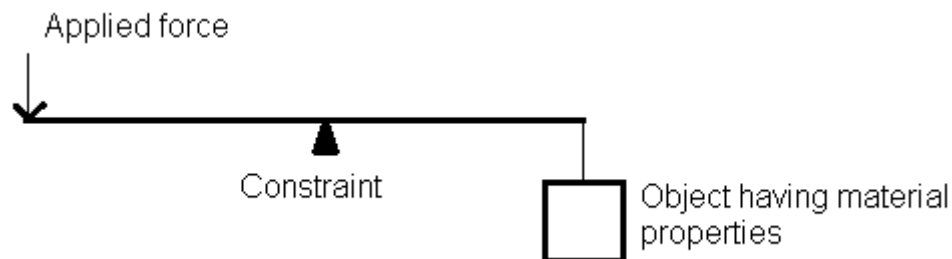

In a mechanics problem the object might be a gear wheel, the force might be applied from another gear, the response might be the tensile and shear stresses throughout the gear wheel and on the supporting shaft. The constraint is that the gear must remain on the shaft.

In an electrostatic problem, the object might be a specially shaped capacitor, the force might be the voltage applied to the anode, the constraint that the cathode is earthed, and the response might be the stored charge and the polarization throughout the material.

The model you build must represent the object plus all these forces, constraints and materials. At the end of the calculation the software will display the results, and then you have to interpret them.

The finite element method is a numerical technique for gaining an approximate answer to the problem by representing the object by an assembly of rods, plates, blocks, bricks – the finite elements -- rather like a child's Lego® model. Each of these building elements is given the appropriate material properties and is connected to adjacent elements at 'nodes' – special points on the ends, edges and faces of the element. Selected nodes will be given constraints to fix them in position, temperature, voltage, etc. depending on the problem. The physics of the situation is built into each element through a variational principle to minimize energy.

Mathematically the assemblage of nodes is represented as a very large matrix. The technique solves a matrix equation

$$[\text{Node matrix describing object and constraints}] \times [\text{Response}] = [\text{Applied 'force'}]$$

The resulting [Response] matrix must then be converted into tables and graphs of values for the user to make use of.

Because the 'Lego®' bricks can easily be assembled into complicated shapes, FEA is a popular and powerful method for realistically predicting the behavior of many engineering structures and components. Computer graphics are used throughout the method to display the model and results.

The finite element method, therefore, has three main stages:

- 1) build the model
- 2) solve the model
- 3) display the results

These can be broken down further:

- Build the model
 - create nodes in positions to represent the object's shape
 - either create in LISA or
 - import from an existing CAD model
 - refine as required.
 - create finite elements (beams, plates, bricks, etc) between the nodes
 - assign material properties to the elements
 - assign constraints to selected nodes
 - assign applied forces to the appropriate nodes.
- Solve the model
 - define the type of analysis you want e.g. static linear, vibrational modes, dynamic response with time, etc.
 - let LISA's Solver do the work.
- Display the results
 - open the results file and select which parameters you want to display e.g. displacement, principal stress, temperature, voltage,
 - display as 2D or 3D contour plots, and/or as tables of numerical values,
 - before inferring anything from the results, they must first be validated,
 - validation requires confirming mesh convergence has occurred and that values are in line with expectations from hand calculations, experiments or past experience,
 - mesh convergence requires refining the mesh repeatedly and solving until the results no longer change appreciably.

1.2 Basic operations in the graphics area

Because the graphics is so much a part of LISA, let us look first at a data file which displays a model and its solution.

1.2.1 Basic graphics tutorial

Step 1

File->Open, 1.2.1_basic_graphics_tutorial.liml in the tutorials folder where LISA has been installed. This is a contrived example merely to show the graphics features.

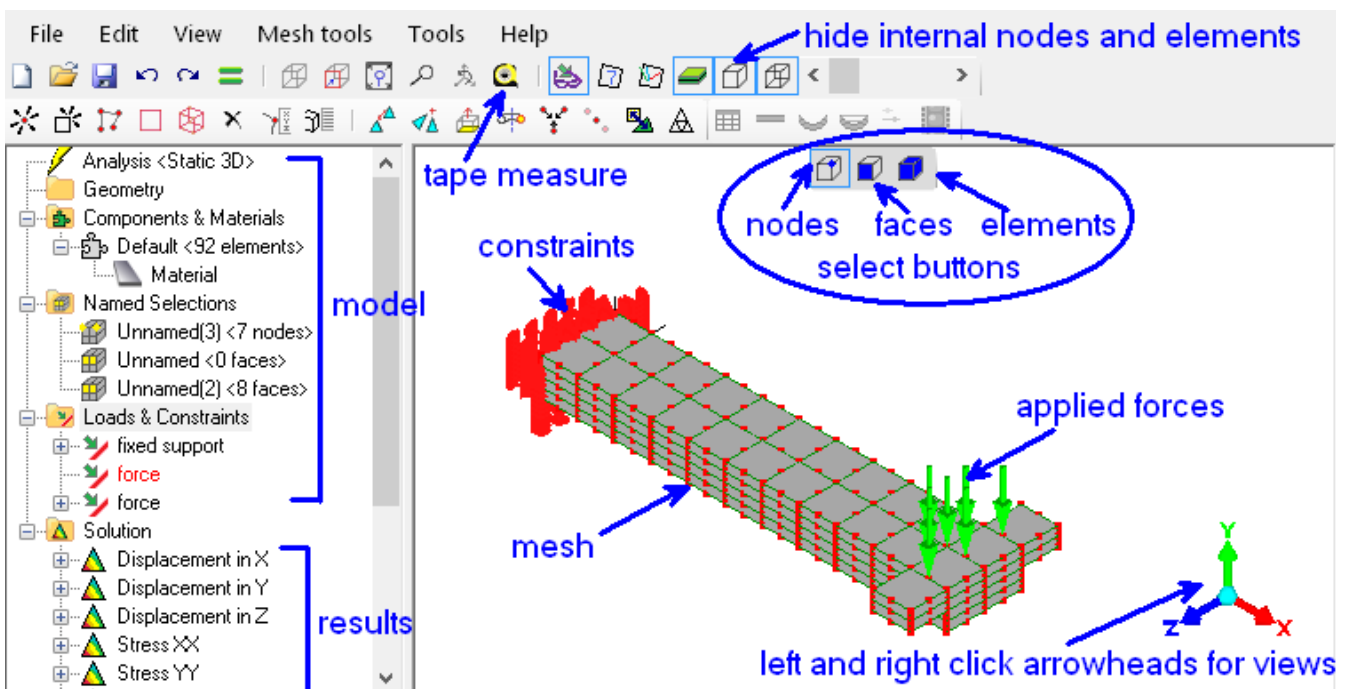

There are three parts to the screen

- the toolbars at the top, arranged into model-building tools and the graphics display options.
- the model structure and solution displayed in an outline tree in the left panel
- a graphic display area of the model

This sample is a beam with a T-shaped end and has already been solved. One end is totally fixed, as if built into a wall. At the free end a downwards force is applied at seven locations. The self-weight of the beam has been neglected.

Step 2

 Toggle the display of element surfaces.

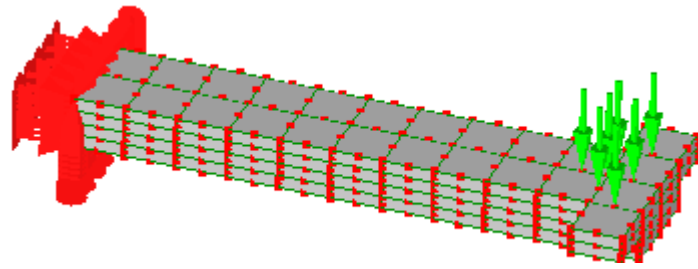

 Toggle element edge display.

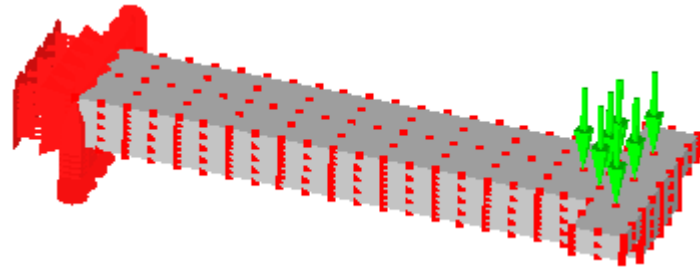

Step 3

 Select nodes

Drag over the model to see that nodes have been selected.

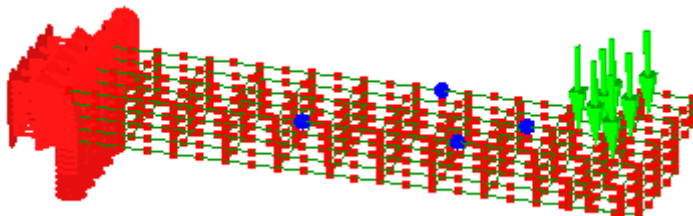
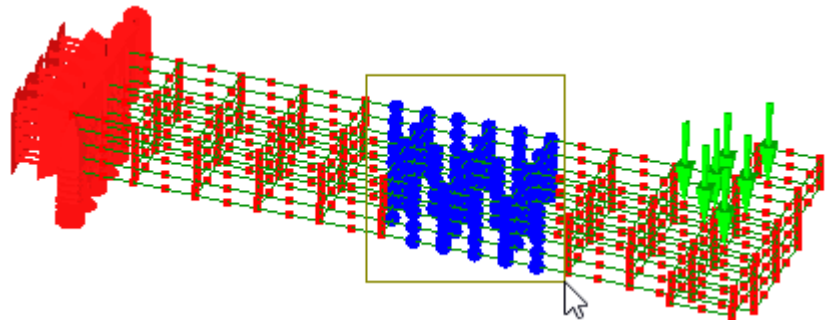

Click in an open space to deselect the nodes. Then left click a node to select it. Hold the **Ctrl** key down and click a couple of nodes to add to the selection set. If a node is already selected and it's clicked on while holding down the **Ctrl** key, it becomes deselected.

Left click to select a node, but keep the mouse button pressed and drag the node to a new location. Repeat the action on another node, but this time hold down the **Shift** key. You'll notice that the node is fixed and cannot be dragged.

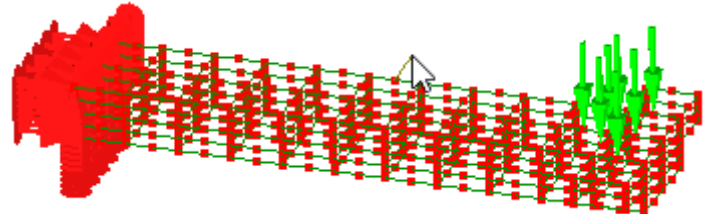

Edit->Undo or **Ctrl + Z** to return the displaced node.

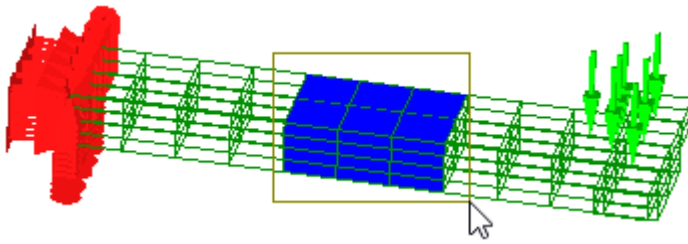

Click in an open space to deselect the nodes.

 Select faces. Drag over the model to see that only surfaces are selected.

Click in an open space to deselect the surfaces.

 Select elements. Drag to see that only elements have been selected.

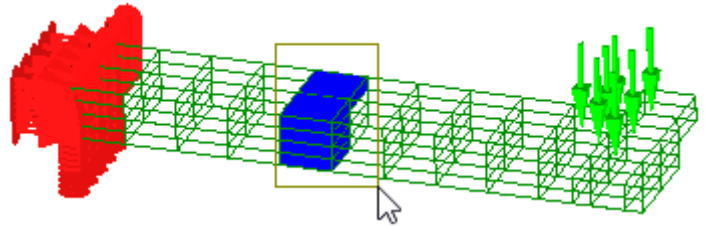

The **Ctrl** key has the same effect while selecting faces or elements as it does with selecting nodes.

Step 4

 The display of loads and constraints can be toggled off or on.

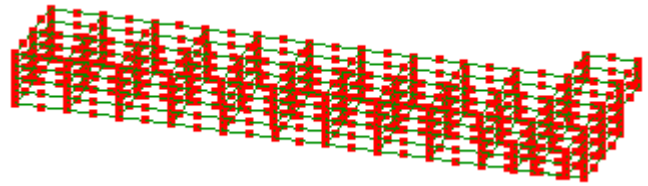

Step 5

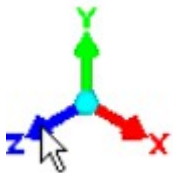

Click the Z arrowhead of the triad at the bottom right corner of the graphics area to view the model parallel to the screen.

Left or right clicking the arrowheads will display the different views of the model parallel to the screen.

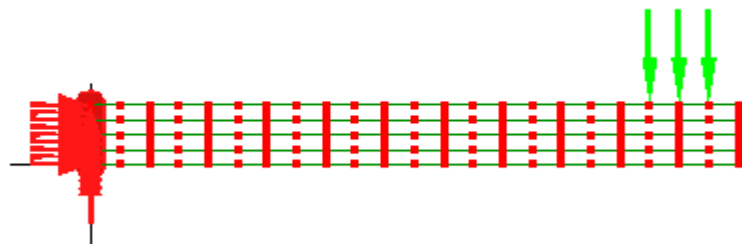



Click the blue dot to return to an isometric view.

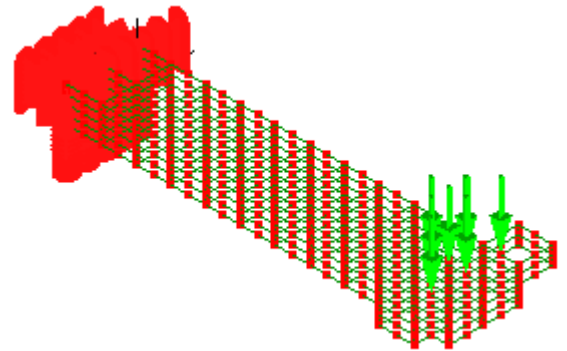

Step 6

Not all of a model's features can be displayed at the same time in the graphics area. Features hidden behind need to be rotated into view. To do this press down and hold the mouse middle button (the mouse middle button is the roller wheel between the left and right mouse buttons) and rotate the models display in the graphics area.

To see a small feature more clearly, zoom into that area by placing the mouse over that area (no clicking required) and rotate the mouse wheel for a larger display of the small feature. Rotating the mouse wheel the other way will make the model's display become smaller.

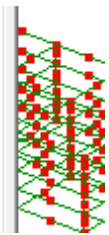

If the model's display seems to be half out of the graphics area, you need to pan the model back into view. Right click the mouse, keep the button pressed and move until the model is completely visible.

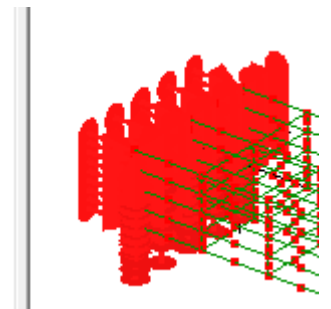

If the model does not fully appear in the graphics area after you have used the zoom, rotate or pan , use the fit to screen tool-button 

Step 7

Use the tape measure tool-button  to check the lengths. Click a node but continue keeping the mouse button pressed and move the cursor across to another node. LISA will give a readout of that distance.

Step 8

Tools->Volume will give volume of the entire mesh. This tool can be used to obtain the volume of a selected part of the mesh. The selection can be element nodes, faces or elements.

Similarly the **Tool->Surface area** will give the area of the selected faces. The selections can only be element faces.

1.2.2 Solution tutorial

Step 1

This tutorial uses the same file as the previous tutorial. So if it is not already open in LISA, use the **File->Open, 1.2.1_basic_graphics_tutorial.liml** in the tutorials folder where LISA has been installed.

In the solution section of the outline tree click on **Displacement in Y**. The graphics display will update to show the results of the solved model. The units used in the legend on the display scale are shown without dimensions. It is up to the user to select and work within a consistent set of dimensions such as SI or Imperial units. In this case, if 1 unit in the model represents 1 meter in reality, then -9.037E-05 units means a displacement of 0.09037 mm in the negative y direction.

Step 2

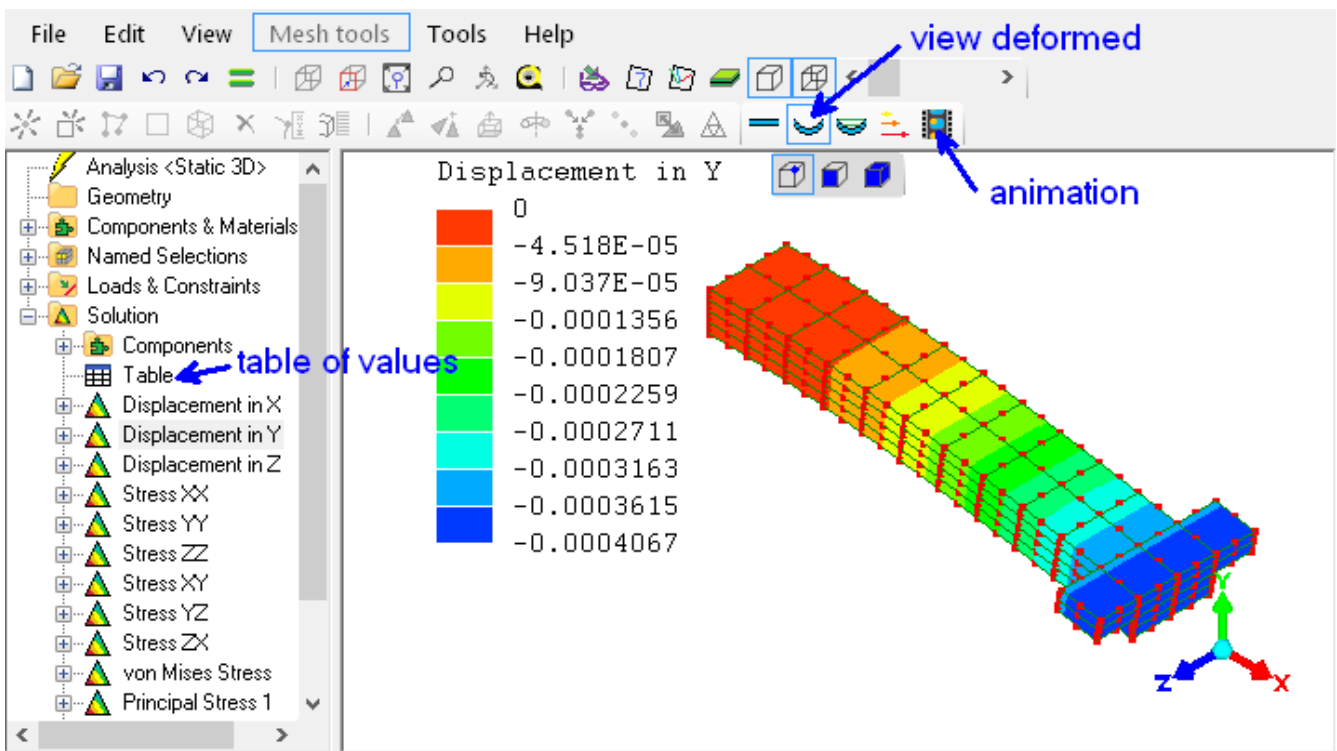

Click the  view deformed tool-button to visualize an exaggerated displacement of the structure.

Click the  undeformed mesh on/off to superimpose an outline of the undeformed mesh onto the deformed mesh.

Click  view undeformed to no longer view the exaggerated displacement.

Step 3

Click the  table tool-button to display the displacements, rotations and stresses at each node in spreadsheet-style cells which you can then copy and paste into your own spreadsheet.

Step 4

Use the  animation tool-button to animate the deflection. Smooth deformation between the two extremes of movement is simulated. You can choose the scale factor. This tool is especially useful for visualizing solutions in vibration analysis.

Step 5

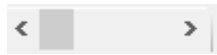

This slider can be used to cut-away the model to look inside it. You will need to rotate the model suitably so that the cut occurs where you want it. Don't forget to return to its leftmost position before doing any editing of the mesh.

To return to the model that does not display the results, click any of the items in the outline tree that is not below **Solution**.

Now that you have some experience in manipulating the graphics of the model, it's time to learn how to create them from scratch. The next section will walk you through the case we have just studied.

Modeling

2.1 The finite element model

This chapter will explain how to use the tools that are available in LISA for creating your finite element model. Unlike computer aided design (CAD) software which uses lines, surfaces and solids, finite element analysis software uses only nodes and elements. It is also possible to import CAD models into LISA and create a suitable mesh with LISA's automeshing tools, but this is described in the more advanced *Tutorials and Reference Guide* installed with LISA.

A finite element model is a mesh of elements. Each element has nodes which are simply points on the element. Elements can only be connected to other elements node-to-node. An element edge-to-element-node is no connection at all. Elements themselves have very simple shapes like lines, triangles, squares, cubes and pyramids.

Each element is formulated to obey a particular law of science. For example in static analysis, the elements are formulated to relate displacement and stress according to the theory of mechanics of materials. In the case of modal vibration the elements are formulated to obey deflection shapes and frequencies according to the theory of structural dynamics. Similarly, in thermal analysis the elements relate temperature and heat according to heat transfer theory. So it is essential that you have an understanding of the underlying physics theory before using finite element analysis software.

When beginning a new model first check whether or not your choice of element shape is actually supported by the type of analysis. The element shapes that are available to each type of analysis are listed in the accompanying *Tutorials and Reference Guide* installed with LISA. That manual contains technical details which you can refer to later.

2.2 Manual meshing

Always begin a manual mesh by creating a coarse mesh; it can always be refined later. A coarse mesh simply means larger and fewer elements, and a refined mesh means smaller and more elements. Creating a coarse mesh requires less labor and, if things go wrong, it will be less frustrating.

Just as in the real world where everything has three dimensions (length, width, height), the geometrical properties of finite elements are also three dimensional in nature. Some elements will appear on the screen as being clearly three dimensional elements, while others will appear on the screen as flat and two dimensional. Nevertheless, the elements that appear flat and two dimensional do actually have the third dimension, of thickness.

Elements that appear three dimensional on the screen will usually be created from a two dimensional flat shape, so modeling typically starts with what appears on the screen as a flat two dimensional mesh. This initial 2D mesh can be created either by a combination of nodes and elements or by using ready-made template patterns. Editing tools are available for modifying the two dimensional mesh as you create and form it. Once the coarse mesh is complete, whether it be two dimensional or three dimensional in appearance, it will need to be refined before running the **Solver**.

To summarize, the manual meshing tools can be grouped together by purpose:

- i. creating tools, that bring into existence a two dimensional mesh
- ii. editing tools, that form and modify the created two dimensional mesh
- iii. tools that will convert the two dimensional mesh into three dimensional meshes
- iv. refinement tools for converging results

Here is a tutorial to illustrate how these tools work together to create the model used in the introductory chapter. We will recreate the T-shaped thick beam used in section 1.2 to illustrate LISA's graphics tools. At the end you may wish to use some of the skills you have learned to modify the length and thickness of the beam to make it more realistic.

2.2.1 T-shaped beam tutorial

Step 1

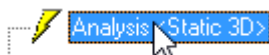

The analysis type should be **Static 3D**. If it's not, right click the item, then select **Edit** to change the analysis type.

Use the **Mesh tools->Create->Node...** or  and enter the following coordinates.

X 0
Y 0
Z 0

Click the **Add** button. Repeat for the following coordinates.

11,0,0
11,1,0
0,1,0

Click the Z arrowhead  to view the XY plane parallel to the screen.

To view the entire model, use fit to screen 



Step 2

Mesh tools->Create->Element... Select **quad4 shell** and click the four nodes. The order of the clicked nodes will affect the orientation of the mesh refinement that will be done in the next step. In this tutorial, the element is formed using the node order 1-2-3-4.

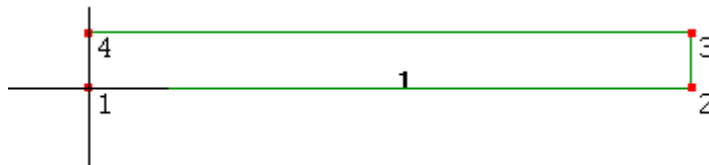

Step 3

Mesh tools->Refine->Custom...

Number of subdivisions

R 11
S 4
T 1

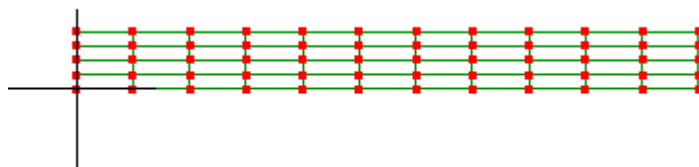

Step 4

Activate select faces 

Drag to select the entire mesh.

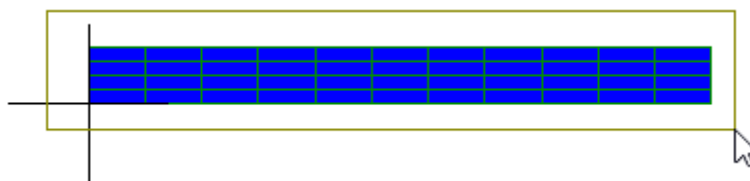

Mesh tools->Extrude...

Direction +Z
Thickness 2
Number of subdivisions 2

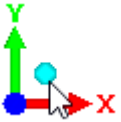

Click the blue dot to view an isometric display of the model.

Click in the open space of the graphics area to deselect the elements.

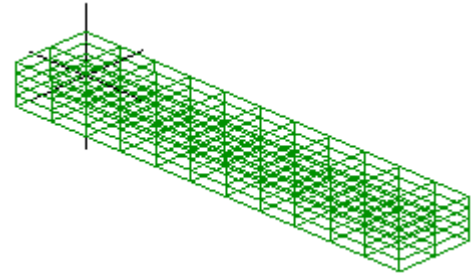

Step 5

Activate select faces 

To improve clarity use the show element surfaces tool-button  to hide the internal elements.

Select these two faces by clicking one face then holding the **Ctrl** key while clicking the second face.

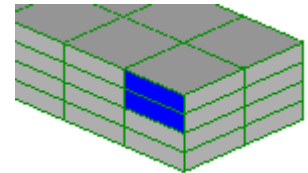

The **Ctrl** key can be used while selecting items. It works by adding the new items to the currently selected items, and if the clicked item is already selected it will become deselected.

Mesh tools->Extrude...

Direction +Z
Thickness 1
Number of subdivisions 1

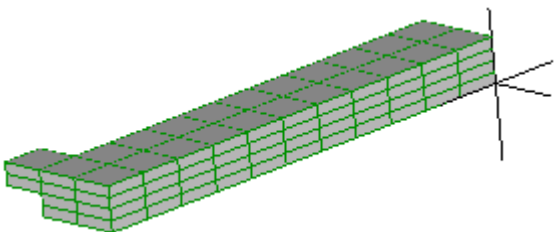
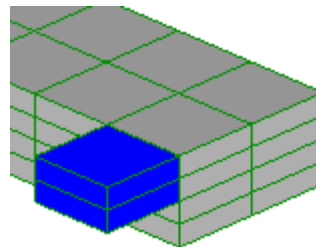

Click and hold down the mouse middle button (it's the roller on the mouse used for scrolling, press and keep it pressed) to rotate the view of the model or use this 

Activate select faces 

Select these two faces.

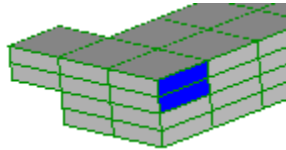

Mesh tools->Extrude...

Direction -Z
Thickness 1
Number of subdivisions 1

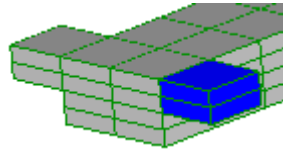

Step 6

Click in an open space of the graphics area to deselect the model.

Activate select nodes  to see that these are 8 node hexahedrons.

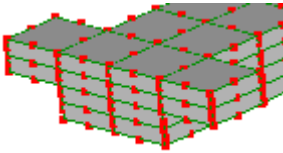
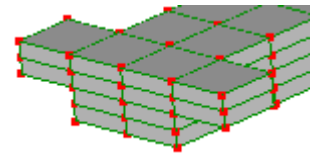

Change these 8 node hexahedrons into the more accurate 20 node hexahedrons using **Mesh tools->Change element shape...** select **hex20** and click OK to accept. The hex8 elements give a linear approximation to the stresses and strains, whilst the hex20 elements give a quadratic approximation.

Step 7

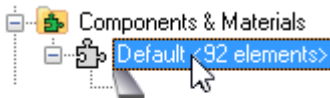

Right click, **Assign new material**

Geometric tab

Thickness 1

Mechanical tab

Isotropic select

Young's modulus 20E10

Poisson's ratio 0.3

A material is now associated with the elements.

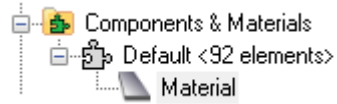

Step 8

In order for a part to develop stresses, all rigid body motion must be resisted. The left face of this model will be constrained.

Activate select faces 

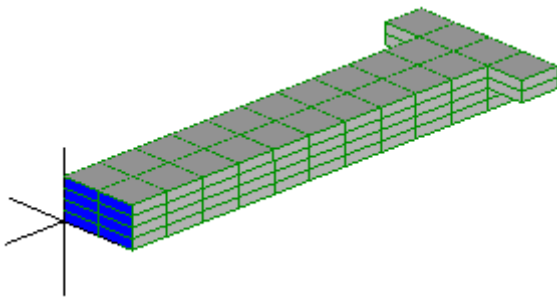

Select this face.

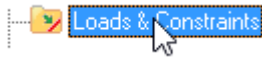

Right click, select **New fixed support** accept the defaults and click OK

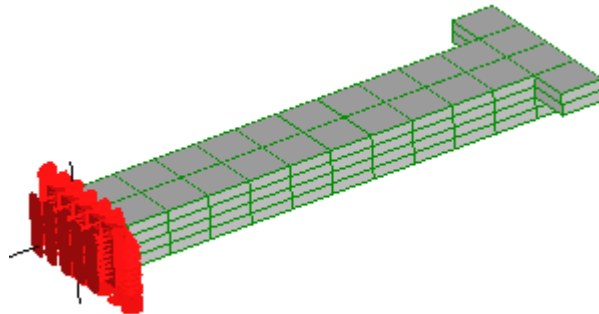

Step 9

Activate select nodes  and select these nodes.

Hold the **Ctrl** key down while clicking to add the nodes so that the nodes already selected don't become deselected.

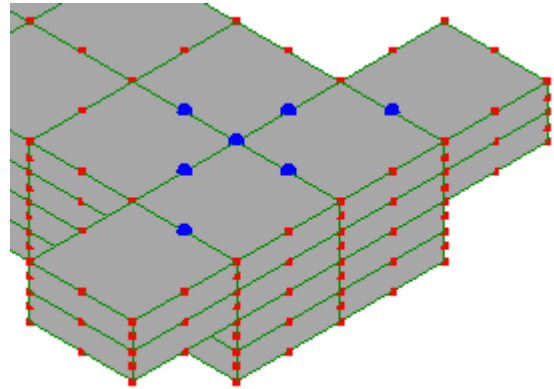

 **Loads & Constraints** Right click, select **New force**
Y -35000

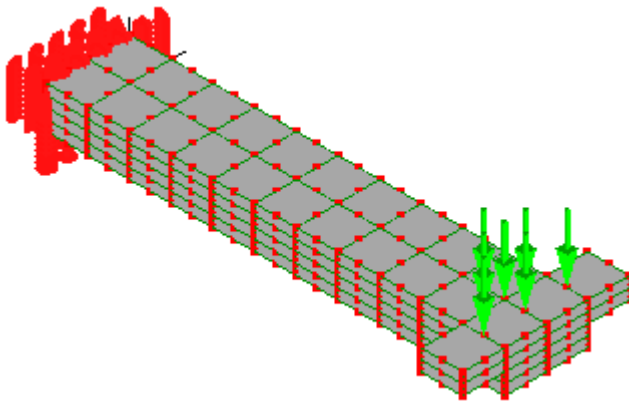

The 3500 force will be divided by the number of selected nodes, which in this case is 7. So each node will effectively have a load of $35000/7$ or 5000.

Step 10

Before you run the **Solver**, check down the outline tree to make sure there are no warnings in red.

Click  to solve the model.

The results are listed in the outline tree below **Solution**.

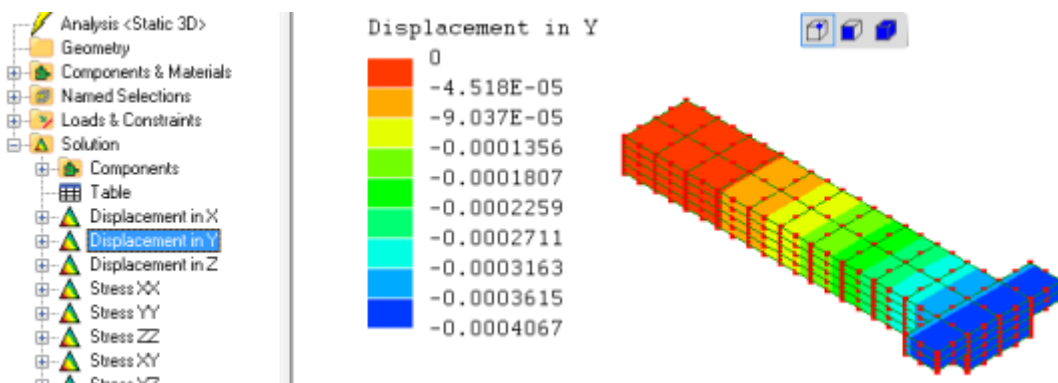



You may now wish to explore LISA's mesh-modifying tools, for instance by scaling the length, width and thickness of the beam using **Mesh tools->Scale...** or changing the applied load and/or elastic constants by right clicking to edit the appropriate item in the outline tree.

2.3 Creating

This section describes in turn each of the tools for creating a mesh. Tools for modifying it are described in Section 2.4

2.3.1 Quick element

If you're making a simple orthogonal model or want to do a quick test on some feature in LISA, use the **Mesh tools->Create->Quick square** or and the  **Mesh tools->Create->Quick cube** or 

They can be used as building blocks for a model by scaling, re-positioning and refining.

2.3.2 New node and New element

Use the **Mesh tools->Create->Node...** or 

if you would like to lay-out the nodes like this...

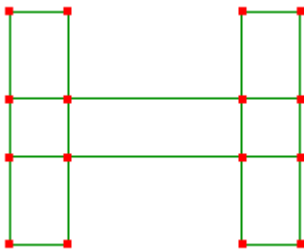

....in order to create the elements by clicking the nodes using

Mesh tools->Create->Element... or .

The order in which the nodes are clicked will affect the direction in which element subdivisions take effect when using the editing tools. So be consistent in how you are clicking the nodes. For example, you can choose to click the nodes by going counter-clockwise starting at the lower left corner.

2.3.3 Insert node between

Select two nodes then use the **Mesh tools->Insert node between** to create a node mid-distance from both nodes. This is useful when laying out nodes for a coarse mesh.

2.3.4 Templates

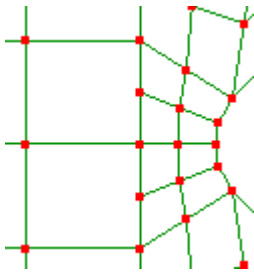

The **Mesh tools->Templates...** is used primarily during the lay-out of a coarse two dimensional mesh.

For example, in this mesh (left) there are two nodes, each lying on an element edge. This mismatch means that there is no connection between the adjacent elements. Using the templates the larger element can be split up into smaller elements so that there is now a node-to-node connection.

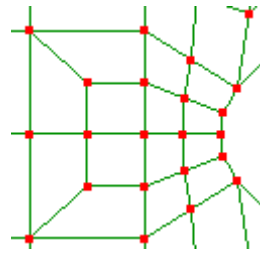

While easy to use for two dimensional meshes, it is not practical to use for three dimensional meshes.

This tool is indispensable for laying out a coarse mesh and its use will be illustrated in the step-by-step modeling tutorials of *Chapter 4*.

2.3.5 Curve generator

The **Mesh tools->Automesh 2D...** is a two dimensional automesh that will mesh any area in the XY plane formed by plane or line elements.

The **Mesh tools->Create->Curve generator...** can be used to create these line element boundaries.

The circle and the arc was made using the curve generator.

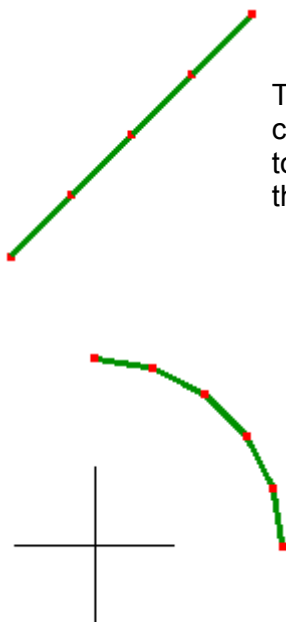
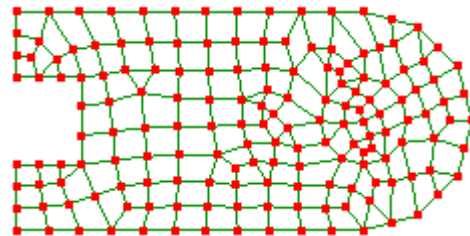
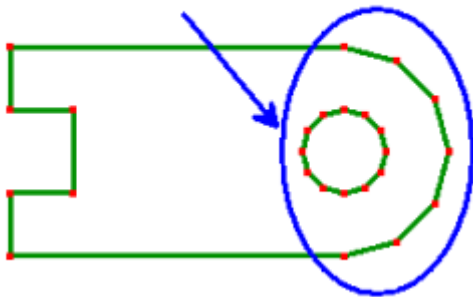

The types of line element boundary that can be created are a straight line, arc, circle, ellipse and parabola. It is not likely that you will use the curve generator to create straight lines as there are other ways to create them such as using the **Mesh tools->Create->Element...**

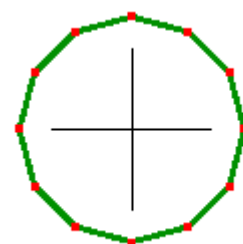

Your most common use of the curve generator will be to create arcs and circles.

Arcs can be created using either the center, start and end points or by specifying the start, end and any point lying on the arc.

You may also create a parabola, but it's not often that you will need one.

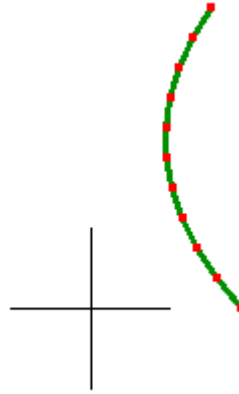

2.3.6 Polyline

The **Mesh tools->Create->Polyline...** tool is used to create continuous straight lines. It is similar to the curve generator tool in that it also creates line element boundaries for use with the two dimensional automesh.

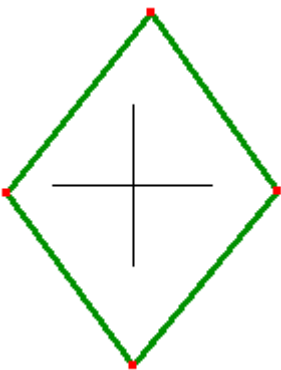

There are two ways to use this tool. The first is to click continually in the graphics display area to create a line element boundary. Since the clicking is arbitrary the nodes will not be accurately positioned. If you need accuracy, select the nodes then right click on the selected node and select **Node coordinates** and type in the correct value.

The second way is to specify either the absolute co-ordinate positions for the end points of the line or distance of the end point relative to the start point of the current line segment.

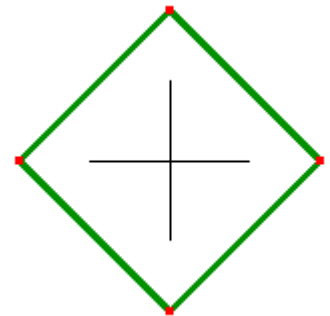

2.3.7 Automesh 2D

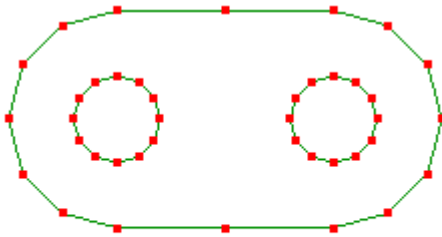

The **Mesh tools->Automesh 2D...** is used to fill an area bounded by line elements or formed by plane elements with either quadrilateral or triangle or a mix of both element shapes. After a successful automesh the original elements will no longer exist. The automesher can create elements only in the XY plane. If you create the original elements in three dimensional space, the automesher will project them onto the XY plane and mesh only the projected area. If the projection on the XY plane appears as a straight line, the automesher will fail. The automesher runs as a separate process in another window.

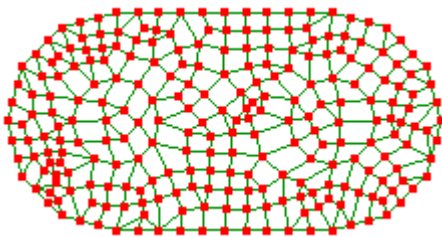

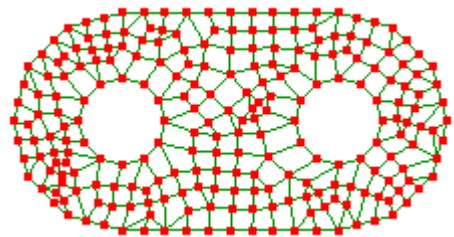

The automesher will fill the entire bounding area with elements including any holes. You will then have to delete manually the elements in the hole areas.

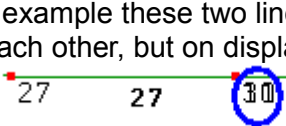

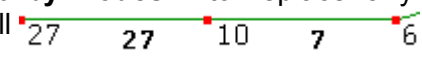
Depending on how you created and edited your model, you may have places where two parts of the bounding lines appear to be joined but are not. For example these two line elements look as though they are connected with each other, but on displaying their node numbers, it's clear that there are actually two overlapping nodes . This means the line elements are not connected to each other.

If there are any unconnected line elements the automesher will fail. Therefore, before running the automesher, always use the editing tool **Mesh tools->Merge nearby nodes...** to replace any overlapping nodes with a shared node, thereby connecting all  elements.

If the automesher default values make a mesh with only a few large elements, re-run the automesher using a smaller value for the **Maximum element size**. If you don't know what maximum size value to specify, use the tape measure  tool to measure the smallest line segment. It will give a dynamic read-out as you click and drag  from one node to another.

By default, quadrilateral elements are set to be the dominant element of the mesh. If you have a good reason for using triangle elements, you may uncheck **Quad dominant**.

You can also use 2nd order elements with midside nodes by checking **Quadratic elements**.

2.3.8 Plates

In **Mesh tools->Create->** there are templates for creating simple shapes like a circular, square and octagonal plate with or without holes. These templates are simple to use and are self-explanatory.

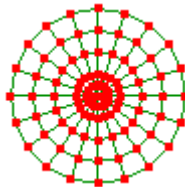
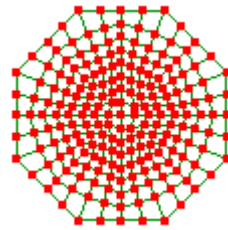
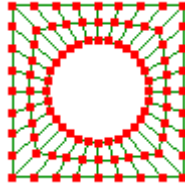

These shapes can be extruded or revolved to generate three dimensional solids.

2.4 Editing

2.4.1 Move

The **Mesh tools->Create->Move/copy...** is used to reposition or duplicate nodes or elements in the **X**, **Y** or **Z** axis directions.



Note the copy check box. If this is ticked, the selection is both moved and duplicated. Bear in mind that the copies are not connected to each other. Use the **Mesh Tools->Merge nearby nodes...** to connect them.

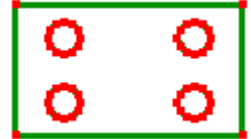

2.4.2 Rotate

The **Mesh tools->Create->Rotate/copy...** is used to rotationally reposition nodes or elements.

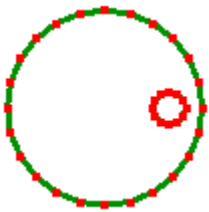

With the copy option selected nodes and elements can be duplicated.

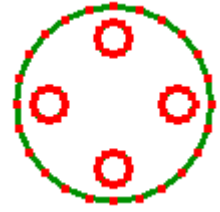

2.4.3 Mirror

The **Mesh tools->Create->Mirror/copy...** is used to reposition nodes or elements by mirroring.

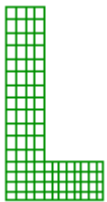

When the **Copy** option is selected, it can be used to mirror meshes.

At the mirror joint the elements will not be connected so you will have to use the **Mesh tools->Merge nearby nodes...** to make it a continuous mesh.

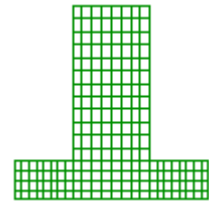

2.4.4 Scale

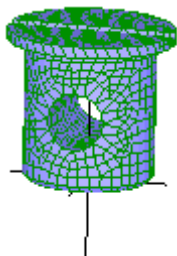

The **Mesh tools->Create->Scale...** is used to re-size either the entire mesh or the selected items. If you're not re-sizing the entire mesh but only a selected portion of the model, you should move it so that it is centered at the origin. This is because scaling is done relative to the origin.

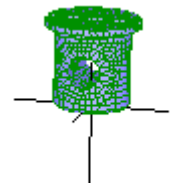

2.4.5 Hollow



The **Mesh tools->Hollow** is used to convert a solid mesh into a shell mesh.



2.4.6 Fit to sphere/cylinder/cone

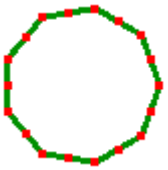

The **Mesh tools->Fit to sphere/cylinder/cone...** is used to smooth circular features that look faceted after they have been refined.

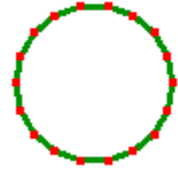

2.4.7 Merge nearby nodes

The **Mesh tools->Merge nearby nodes** will ensure that the elements are connected node-to-node by replacing overlapping nodes with a single shared node. Meshing operations such as **Mesh tools->Refine->Custom...** or **Mesh tools->Templates...** or **Mesh tools->Move/Rotate** with the Copy option will create meshes that are not connected. Separate files assembled using **File->Load into model...** will also not be automatically connected to each other at the mating surface.

The **View->Open cracks** tool will expose unconnected elements. It shrinks elements slightly to open up any existing gap between adjacent faces of unconnected elements.

To eliminate these gaps use the **Mesh tools->Merge nearby nodes** to delete overlapping nodes. You have to specify a radial distance within which two or more nodes will be replaced by a single node. Too small a value and all the overlapped nodes will not be eliminated. Too large a value and you risk collapsing elements as they lose a node. Use the **Tape Measure** tool  to determine the smallest distance between two nodes in your mesh, then use a value smaller than this so that elements don't collapse. You will notice the change in node numbers in the status bar after using this command.

Always use this tool after all meshing has been completed and before applying loads and constraints. Then use the **View->Open Cracks** to confirm that you got it right.

2.4.8 Delete unused nodes

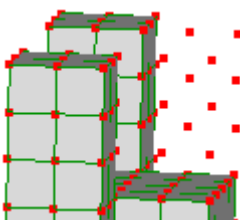

The **Mesh tools->Delete unused nodes** will remove any node not belonging to an element.

If you use **Edit->Delete elements and retains nodes**, the nodes will be left behind. If you can't see them,

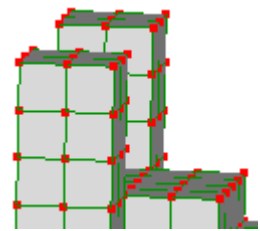

activate the node select mode

2.4.9 Invert

If the solver fails with a message about incorrect element topology, you can select the affected elements and use the **Mesh tools->Invert** to fix their topology.

2.5 Converting a two dimensional mesh into a three dimensional mesh

The following tools work only in the face selection mode 

2.5.1 Extrude



Select the faces then use **Mesh tools->Extrude...** to create a 3D solid mesh.



2.5.2 Revolve

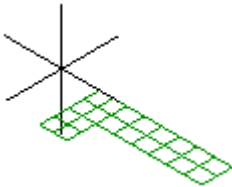

Select the faces then use **Mesh tools->Revolve...** to create a 3D solid mesh.

If there are nodes at radius = 0, badly shaped elements will be created there. To fix this problem first run the **Mesh tools-> Merge nearby nodes...** then use **Mesh->Correct collapsed elements**.

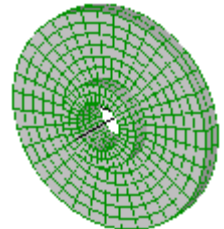

2.5.3 Loft

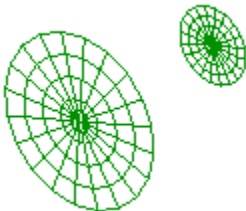

This tool is useful for creating tapered solids. For example first create a two dimensional mesh, next copy/move it to a new location and then scale it to give you a second two dimensional mesh that is similar in shape but different in size. The **Mesh tools->Loft...** can then be used to create a 3D solid mesh between the two meshes.

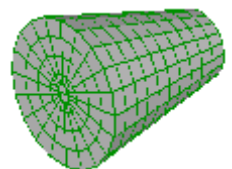

2.6 Refinement

The results of a finite element analysis are reported at the element nodes. If you were solving for the stress, temperature, magnetic field, etc. and these field values were the same over a large area, it would not matter whether you used more or fewer elements over that area – the results would be the same. However, if these values were to change rapidly over an area and you used very few elements over that area, the mesh will not accurately capture the change in value that is occurring.

To illustrate the need for refinement when a value changes greatly, consider the geometry of a circle created by using straight lines.

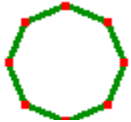

If very few lines are used, it will not represent the circle very well.

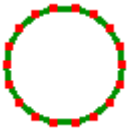

If more lines are used, it will represent the circle more closely.

Likewise, in finite element analysis to represent a field value that is changing rapidly you have to use more elements over that region. To achieve this use the following mesh refinement tools.

2.6.1 Refine x2

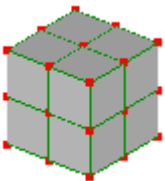

Mesh tools->Refine->x2 replaces every element with two elements along each edge.

Excellent for refining a coarse mesh, provided the model size doesn't get much past 100,000 nodes. For hexahedron elements, this increases the number of elements 8-fold so if the mesh is already

large it will probably run out of memory when solved.

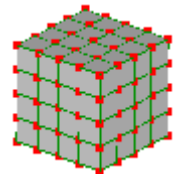

2.6.2 Refine Custom

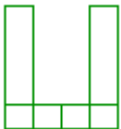

Mesh tools->Refine->Custom... is used to subdivide elements by specifying the number of subdivisions along three dimensions. If no elements are selected, it subdivides the entire mesh.

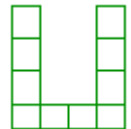

2.6.3 Quad local refinement x2

Local mesh refinement is useful for adding more elements to only those areas with a rapid change in field value, while leaving fewer elements in areas where the field changes more slowly. This is effective in not bloating the size of the model which can happen when using **Mesh tools->Refine->x2**

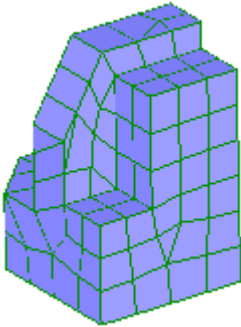

Mesh tools->Refine->Quad local refinement x2... is used to refine shell elements by subdividing the selected faces into two elements along each direction, then merging the subdivided elements with the rest of the mesh so that the elements are connected node-to-node.

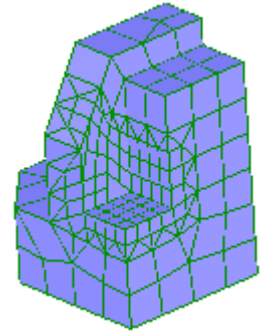

2.6.4 Quad local refinement x3

Similar to the quad local refinement x2, the **Mesh tools->Refine->Quad local refinement x3...** refines the selected faces by subdividing it into three elements along each direction.

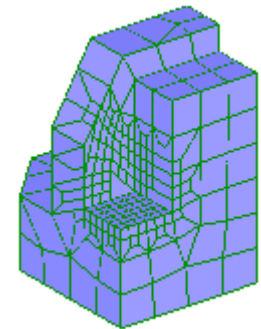

2.6.5 Change element shape

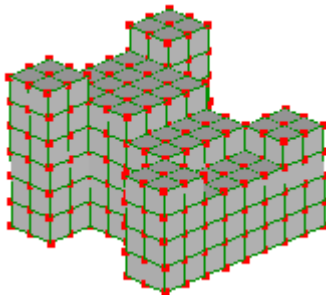

Results can converge faster by changing to higher order elements using **Mesh tools->Change element shape...**

The choice of element shapes will be enabled or disabled according to the element shapes present, so you might have to repeat this step to get the final desired element.

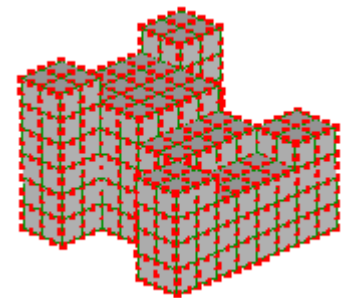

To determine the areas that need mesh refinement you will first need to solve a coarse mesh and click the nodes in the solution for a read-out of the field value. If you find the field value is changing by a large amount over a small area, that tells you the area needs more elements.

You should note down the values in the corresponding areas of a coarse mesh and a refined mesh and calculate the % change in the results. If the % difference in the results of the coarse and refined mesh is very small, such as 3%, the results can be said to have **converged** and no gains in accuracy are to be achieved by further mesh refinement. If the % difference in the results is large -- for example 20% -- then further refinement is required.

To not have to reapply loads and constraints to a mesh that is to be refined, apply the loads and constraints to **Named Selections** in the coarse mesh rather than applying them to nodes directly.

You will get to practice using these tools in *Chapter 4* where the creation of three complex geometries are explained step-by-step.

The next chapter is a step-by-step walk through for each of the various analysis types that can be modeled in LISA.

Analysis Types

While the typical user does not need an in-depth study of the mathematics behind finite element analysis, you do need to understand the behavior of elements, in order to represent a given physical problem correctly. This understanding will influence your choice of element type, element size, element shape, constraints, loads, etc.

The expected learning curve for new entrants into finite element analysis will be the same as the experiences of other analysts gone before, as shown below :

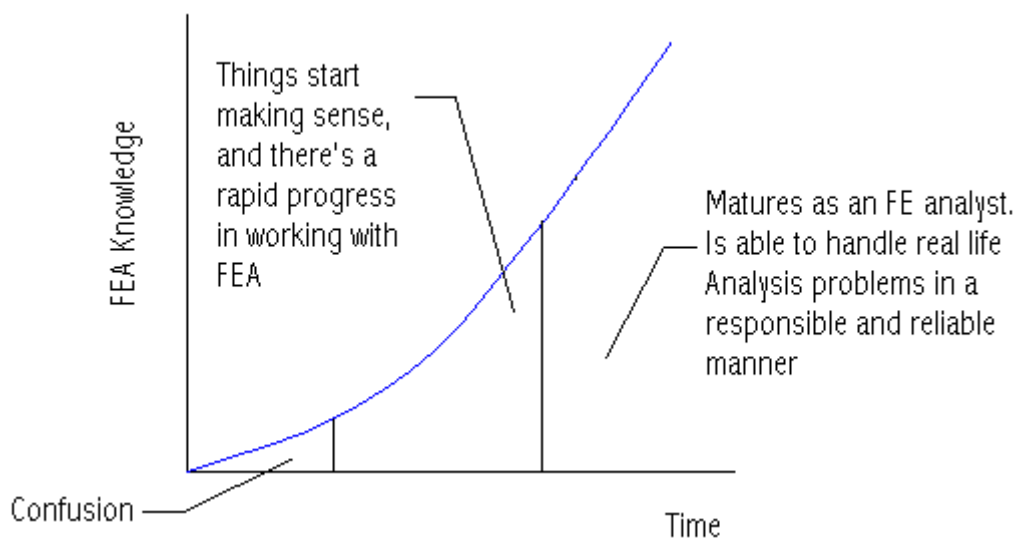

The finite element method uses a mathematical formulation of physical theory to represent physical behavior. Assumptions and limitations of theory (like beam theory, plate theory, Fourier theory, etc.) must not be violated by what we ask the software to do. A competent user must have a good physical grasp of the problem so that errors in computed results can be detected and a judgment made as to whether the results are to be trusted or not.

Finite element analysis is not like CAD (computer aided design) software where you simply create a geometry and take a print-out. Instead, it follows the law of 'Garbage in, Garbage out'. Your choice of element type, mesh layout, correctness of applied constraints will directly affect the stability and accuracy of the solution.

We recommend to beginners that you confine your models to text-book problems with known solutions rather than attempting real world problems with unverifiable solutions. When you get to the point where you're solving real world problems, never accept the results at face value. Rather, validate them by comparing the results to hand calculations, experimental observations or knowledge from past experience.

This chapter contains tutorials to initiate you into using LISA's basic analysis capabilities. Advanced capabilities like modeling thermal-stress problems, composite materials, cyclic symmetry, coupled nodes, mixed material and mixed element models are described in the *Tutorials and Reference Guide*.

LISA works only with numerical quantities. It does not differentiate between N/m^2 and N/mm^2 . This means that you must use a consistent system of units throughout your analysis. For example, if you're using millimeter for length, then Young's modulus should be in N/mm^2 and not N/m^2 . If you're using N/m^2 for Young's modulus then use N for force, not kN.

Not all types of elements can be used for all types of analysis. The *Tutorials and Reference Guide* lists the elements that are available for use in each type of analysis. When creating elements, if you see an N/A ('not applicable') next to the type of element, it means it can't be used to solve that type of analysis. However, you can use non-applicable elements as construction tools provided you change them using **Mesh tools->Change element shape...** , or delete them.

line2	beam/truss
line3	N/A
tri3	N/A
tri6	shell
quad4	shell

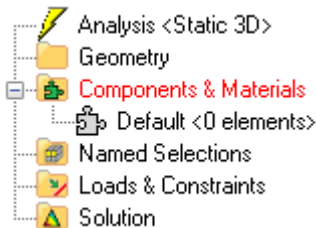

The outline tree presents all the information you need about your model and allows you to perform various actions on the model itself. You will always begin at the top, changing the analysis type if you do not want the default, 3D static analysis.

Items that appear in red indicate missing or erroneous information, so right click them for a **What's wrong?** clue.

 As you create the mesh, information will be added to **Components & Materials** and **Named Selections**. Try to apply your loads and constraints to *element faces* rather than *nodes*. Mesh refinements will automatically transfer *element face* loads and constraints to the newly created elements, whereas loads and constraints applied to nodes are not automatically transferred to the new elements.

The constraints and loads that you apply will be listed in the **Loads & Constraints** section. After solving the model the field values will be listed below **Solution**.

3.1 Static analysis of a pressurized cylinder

A cylinder of 2m radius, 10m length, 0.2m thickness, Young's modulus 15000 N/m² and Poisson ratio 0.285 will be analyzed to determine its hoop stress caused by an internal pressure of 100N/m².

From shell theory, the circumferential or hoop stress for a thin cylinder of constant radius and uniform internal pressure is given by :

$$\sigma = (\text{pressure} \times \text{radius}) / \text{thickness}$$

$$\sigma = (100 \times 2) / 0.2$$

$$\sigma = 1000 \text{ N/m}^2$$

Step 1

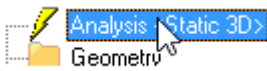

Check that the default analysis type is Static 3D.

Step 2

Mesh tools->Create->Create curve generator... select **Straight line**

X1	2
Y1	0
Z1	0
X2	2
Y2	0
Z2	10
Number of nodes	12

Use the **Fit to screen**  to display the elements.

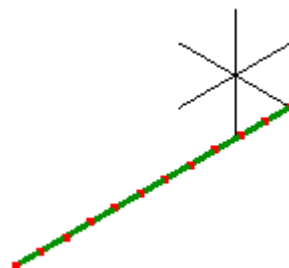

Step 3

Due to the axial symmetry, only one quadrant will be modeled.

Activate select faces 

Drag to select all the elements.

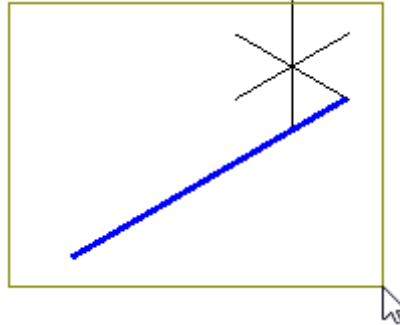

Mesh tools->Revolve...

Axis of revolution

+Z

Angle

90

Number of subdivisions

8

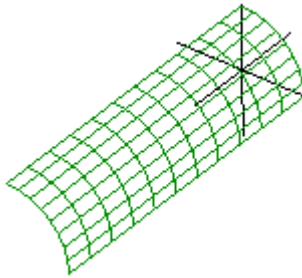

Step 4

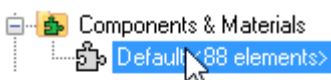

Right click, **Assign new material**

Geometric tab

select **plate/shell/membrane**

Thickness 0.2

Mechanical tab



select **Isotropic**

Young's modulus 200E9

Poisson's ratio 0.285

Step 5

Right click the X arrowhead  to view the YZ plane parallel to the screen.



Activate select faces,  activate show element surfaces,  and activate show shell thickness 

Because of the mirror symmetry only one quadrant of the cylinder has been modeled. At the planes of mirror symmetry, the nodes must be constrained so that they do not move out of the plane. Also, no bending must occur in that plane of symmetry.

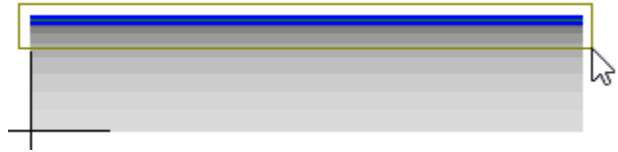

To enforce mirror symmetry at the edge in the YZ plane, drag to select the thickness of the shell.



 **Loads & Constraints** Right click, **New displacement**
X 0



While the shell thickness is still selected, activate select nodes  and toggle off the show element surfaces 

 **Loads & Constraints** Right click, **On selected nodes->New rotz**
Value 0

Right click the Y arrowhead  to view the ZX plane parallel to the screen.
Activate show element surfaces  and activate select faces 



To enforce mirror symmetry at the edge in the ZX plane, drag to select the thickness of the shell.

 **Loads & Constraints** Right click, **New displacement**
Y 0

While the shell thickness is still selected, activate select nodes  and toggle off the show element surfaces 

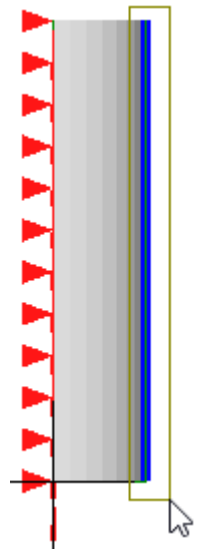
 **Loads & Constraints** Right click, **On selected nodes->New rotz**
Value 0



Activate select faces,  activate show element surfaces,  and activate show shell thickness 

Click the Z arrowhead  to view the XY plane parallel to the screen.

To eliminate rigid body translation motion along the Z axis drag to select the shell thickness in the XY plane.

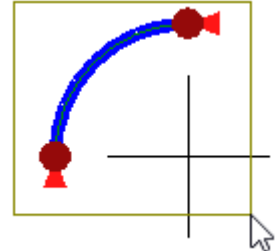

 **Loads & Constraints** Right click, **New displacement**
Z 0

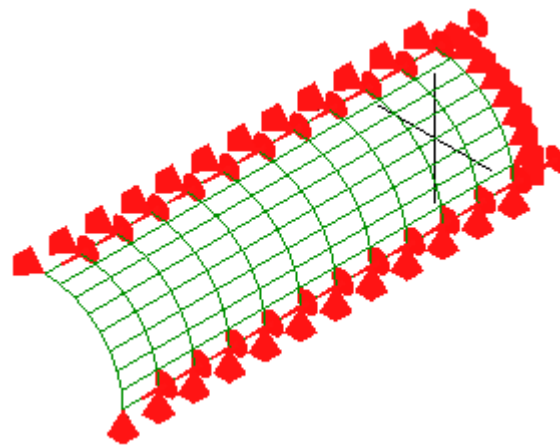

Step 6

Activate select faces 

Drag to select the entire mesh

 **Loads & Constraints** Right click, **New pressure**
Normal -100

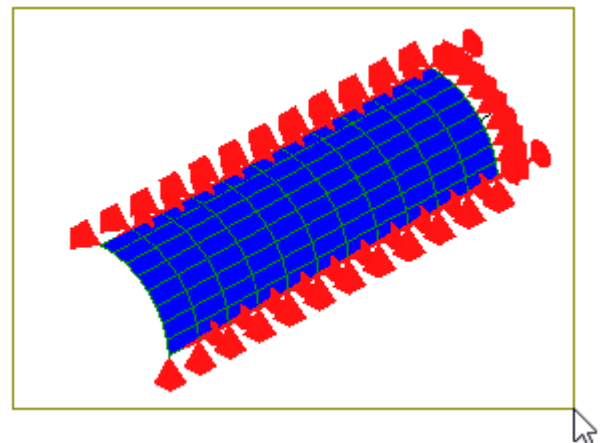



Step 7

Click  to solve the model.

The results are listed in the outline tree below **Solution**. Click  **von Mises Stress, Membrane** to view the hoop stress.

The first thing to check is the deformation. Errors in the applied constraints or loads can show up in the deformation shape.

Click the Z arrowhead  to view the XY plane parallel to the screen.

Click the **View deformed**  tool-button and accept the default values.

Click the **Undeformed mesh on/off** tool-button  to superimpose the undeformed geometry onto the deformed geometry.

Observe that the nodes in the YZ and ZX plane remain in these planes and no bending has occurred, this indicates that the constraints applied to enforce symmetry are working. The fact the deformation expands outward radially indicates that the internal pressure has been correctly applied.

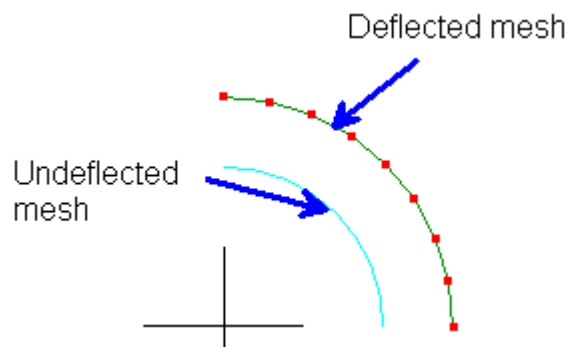

von Mises Stress, Membrane

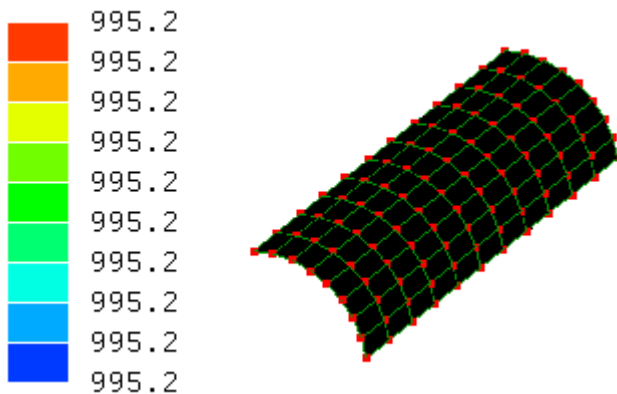

The computed hoop stress is only 0.48% different from the hand calculations. This is close enough not to need further mesh refinement.

3.2 Thermal analysis of a plate being cooled

A plate of cross-section thickness 0.1m at an initial temperature of 250°C is suddenly immersed in an oil bath of temperature 50°C. The material has a thermal conductivity of 204W/m/°C, heat transfer coefficient of 80W/m²/°C, density 2707 kg/m³ and a specific heat of 896 J/kg/°C. It is required to determine the time taken for the slab to cool to a temperature of 200°C.

For Biot numbers less than 0.1, the temperature anywhere in the cross-section will be the same with time. A quick calculation shows that this is true.

$$Bi = hL/k = (80)(0.1)/(204) = 0.0392$$

The 4 node quadrilateral element interpolates temperature linearly, and is able to represent unsteady states of heat transfer so this element will be selected for the model.

We need to have a rough estimate of the time required to reach a temperature of 200°C. In this case, from classical heat transfer theory the following lumped analysis heat transfer formula can be used.

$$(T(t)-T_a)/(T_o-T_a) = e^{-(mt)}$$

T_a = temperature of oil bath

T_o = initial temperature

where $m = h / \rho C_p(L/2)$

h = heat transfer coefficient

ρ = density

C_p = specific heat

L = thickness

$$m = 80 / [(2707)(896)(0.1/2)]$$

$$m = 1/1515.92 \text{ s}^{-1}$$

$$(200 - 50) / (250 - 50) = e^{-(t/1515.92)}$$

$$t = \ln(4) \times 1515.92$$

$$t = 436 \text{ s}$$

Step 1

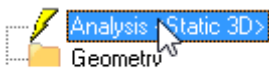

Right click, **Edit**. Select **3D**, then select **Thermal Transient**

Number of time steps 450

Time step 1

The total duration of this analysis is 450 × 1sec = 450 sec or 7 1/2 minutes.

The **Decimation number of time steps** is a way to reduce the memory required for storing the solution. This model is simple enough that we can use the default *All*. For larger models you could choose to save every 10th or 100th solution of a transient analysis, thereby significantly reducing memory requirements.

A slider is displayed to show the duration of the analysis, which in this case is 450 seconds. It will be utilized when viewing the results.

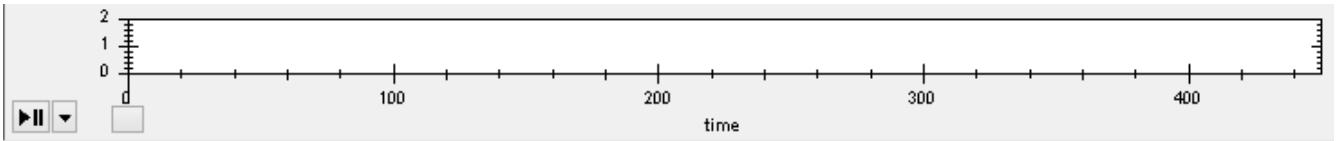

Step 2

Click the Z arrowhead  to view the XY plane parallel to the screen.

Mesh tools->Create->Node...

X 0
Y 0
Z 0

The node appears as a red dot at the origin.

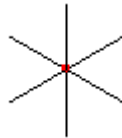

If you don't see the node make sure you've activated the node select mode 

Add more nodes using the following coordinates.

(0.1,0,0)
(0.1,0.2,0)
(0,0.2,0)



Use the **Fit to screen**  to display the nodes.



Step 3

Mesh tools -> Create > Element... Select **quad4 shell** and click the four nodes. The order of nodes will affect the way the element gets subdivided in a following step. So, to keep the order the same, start at the lower left corner and go counter-clockwise.

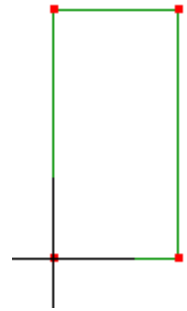

Step 4

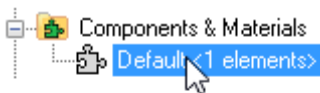

Right click, select **Assign new material**

Geometric tab

Plate/shell/membrane select
Thickness 1

Mechanical tab

Isotropic select
Density 2707

Thermal tab

Isotropic select
Thermal conductivity 204
Specific heat 896

Step 5

Activate select faces 



Select the element.

Mesh tools->Refine->Custom...

R 4
S 8



Step 6

Activate select nodes 

Convective heat transfer takes place along the surface of the entire plate. For the FE model, this will be the left and right edges. Click and drag the mouse over the nodes of the left edge so that they become selected. Hold the **Ctrl** key down and repeat it for the nodes on the right edge.

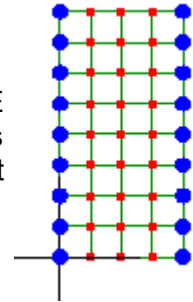

Activate select faces 

The element edges are now selected.

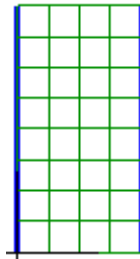

Right click  **Loads & Constraints** then select **New convection**

Ambient temperature 50
Heat transfer coefficient 80



Step 7

Activate select faces 

Drag a rectangle to select the entire mesh.

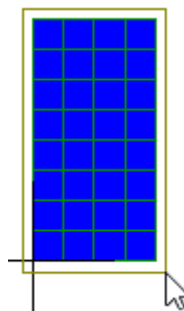

 **Initial Conditions** Right click and select **New temperature**, type 250 in the text-box.

Step 8

Click  to solve the model. The results are listed in the outline tree below **Solution**.

Click  **Temperature**

Drag the slider to view the temperature changes with time.

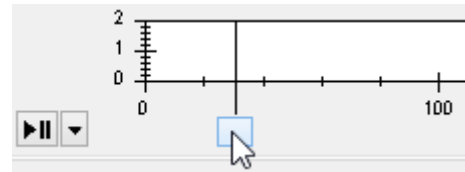

If you click a node the temperature profile of that node will be displayed in the timeline.

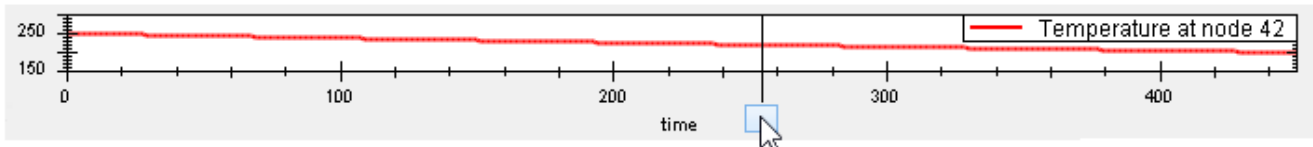

Temperature

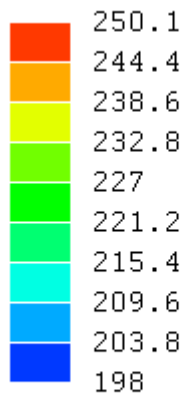

Time = 440
= 7.333333 × 60

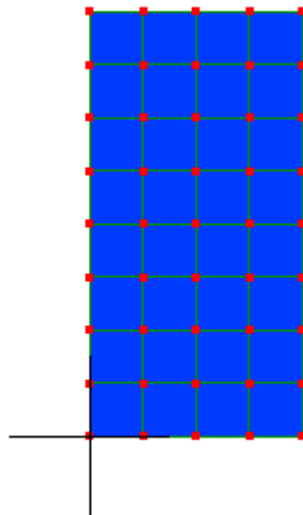

From the results we see that it takes about 440 seconds to reach the temperature of 200°C.

For transient thermal models if your results show a strange oscillation of temperatures every other time-step, use a smaller time-step value and refine the mesh further. If the solver stops with an out of

memory error message use **decimation** as explained in the accompanying *Tutorials and Reference Guide*.

3.3 Modal vibration of a cantilever beam

A cantilever beam of length 1.2m, cross-section 0.2m × 0.05m, Young's modulus 200×10^9 Pa, Poisson ratio 0.3 and density 7860 kg/m^3 . The lowest natural frequency of this beam is required to be determined.

For thin beams, the following analytical equation is used to calculate the first natural frequency :

$$f = (3.52/2\pi)[(k / 3 \times M)]^{1/2}$$

f = frequency

M = mass

$$M = \text{density} \times \text{volume}$$

$$M = 7860 \times 1.2 \times 0.05 \times 0.2$$

$$M = 94.32 \text{ kg}$$

k = spring stiffness

$$k = 3 \times E \times I / L^3$$

I = moment of inertia of the cross-section.

E = Young's modulus

L = beam length

$$I = (1/12)(bh^3)$$

$$I = (1/12) (0.2 \times 0.05^3)$$

$$I = 2.083 \times 10^{-6} \text{ m}^4$$

$$k = (3 \times 200 \times 10^9 \times 2.083 \times 10^{-6}) / 1.2^3$$

$$k = 723.379 \times 10^3 \text{ N/m}$$

$$f = (3.52/2 \times 3.14) [(723.379 \times 10^3 / 3 \times 94.32)]^{1/2}$$

$$f = 28.32 \text{ Hz}$$

Step 1

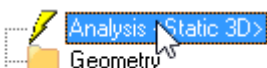

Right click, **Edit**, Select **2D**, then select **Modal Vibration 2D Plane and Truss**.
Number of modes 3

Step 2

Mesh tools->Create->Node...

X 0
Y 0
Z 0

The node appears as a red dot at the origin.

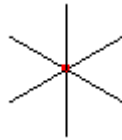

If you don't see the node make sure you've in the node select mode 

Click the Z arrowhead  to view the XY plane parallel to the screen.

Add more nodes using the following coordinates.

(1.2,0,0)
(1.2,0.05,0)
(0,0.05,0)



3
2

Use the **Fit to screen**  to display the nodes.

Step 3

Mesh tools -> Create -> Element... Select **quad4 plane** and click the four nodes. The order of the clicked nodes will affect the orientation of the mesh refinement that will be done in the next step. In this tutorial the element is formed using the node order 1,2,3,4.

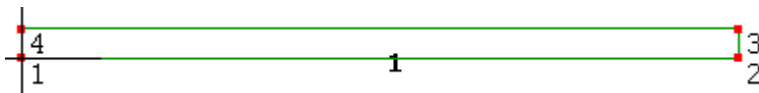

Step 4



Right click, **Assign new material**

Geometric tab select **plate/shell/membrane**

Thickness 0.2

Mechanical tab

Isotropic select

Young's modulus 200E09

Poisson's ratio 0.3

Density 7860

Step 5

Mesh tools->Refine->Custom...

Number of subdivisions

R 16

S 1

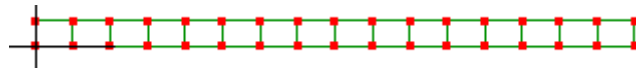

Step 6

Elements with a mid-side node (quadratic) are more flexible in bending problems. These four node quadrilaterals will be changed into eight node quadrilaterals using **Mesh tools->Change element shape...**, select **quad8**

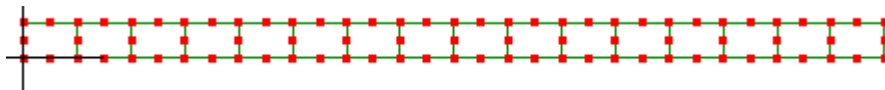

Step 7

Activate select nodes 

Drag to select the nodes at the left edge.

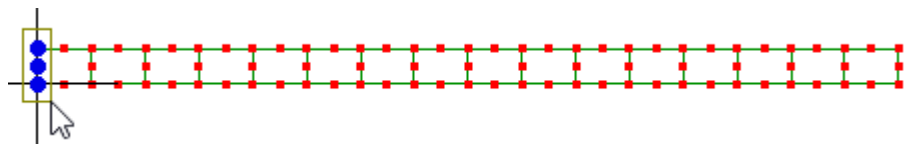

Activate select faces 

The element face at the left is  now selected.

Right click  **Loads & Constraints** then select **New fixed support**



Step 8

Click  to solve the model.

The results are listed in the outline tree below **Solution**. Click  **Mode 1 <28.37391>**

Click the animation  tool-button to view the mode shape. For this problem, the lowest mode shape is expected to vibrate back and forth in bending.

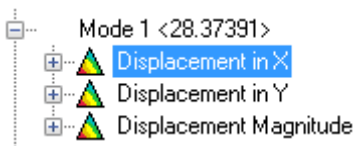

The actual displacement numbers of a modal analysis have no meaning, they simply serve the purpose of providing a visualization of the deflection.

Angular freq. = 178.2785
Frequency = 28.37391

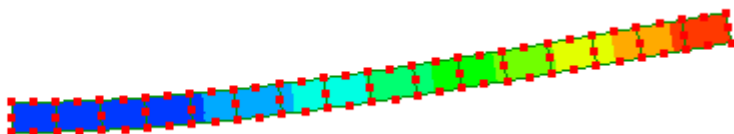

The frequency for the lowest mode matches the hand calculation.

3.4 Dynamic response of a crane frame

A dynamic response analysis is difficult to estimate values for by simple hand calculations. This tutorial will simply illustrate the dynamic response analysis work-flow of a crane's truss framework.

Step 1

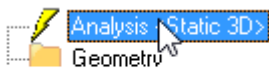

Right click, **Edit**. Select **2D**, then select **Dynamic Response**
Number of time steps 100
Time step 0.005

The **Decimation number of time steps** is a way to reduce the memory required for storing the solution. This model is simple enough that we can use the default *All*. For large models you could choose to save every 10th or 100th time step of the solution, reducing memory requirements to a fraction of the default *All*.

Step 2

Mesh tools->Create->Create curve generator... select **Straight line**

X1 0
Y1 0
Z1 0
X2 20
Y2 0
Z2 0
Number of nodes 5

Click the Z arrowhead  to view the XY plane parallel to the screen.

Use the **Fit to screen**  to display the whole mesh.



Activate select elements 



Drag to select all the elements. Right click on the selected elements and select **Element properties**. Select the check-box next to **Truss** to convert these elements from beam elements to truss.

Step 3

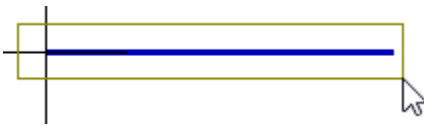

Select the entire mesh.

Mesh tools->Move/copy...

Y 5
Copy select



Step 4

Activate select nodes 

Mesh tools->Create->Element... Select **line2** **N/A** and click the nodes to form the following pattern.

- 1,6
- 2,7
- 3,8
- 4,9
- 5,10
- 6,2
- 7,3
- 8,4
- 9,5

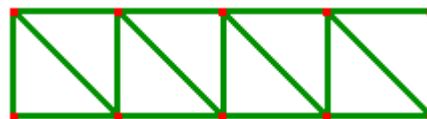

Step 5

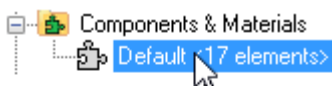

Right click, **Assign new material**

Geometric tab
General section select
Cross-sectional area 0.0225

Mechanical tab
Isotropic select
Young's modulus 200E09
Poisson's ratio 0.3
Density 7860

Step 6



Activate select nodes

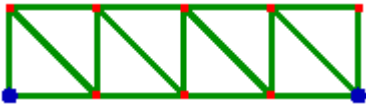

Select these two nodes. Hold the **Ctrl** key down while selecting the second node so as not to deselect the first node.

Right click  **Loads & Constraints** then select **New displacement**, select **Y**, accept the default 0 value.

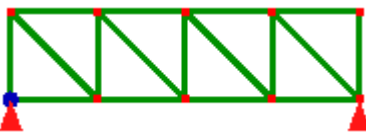
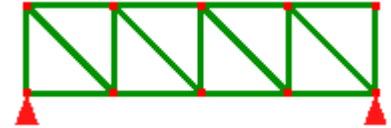

Select this node.

Right click  **Loads & Constraints** then select **New displacement**, select **X**, accept the default 0 value.

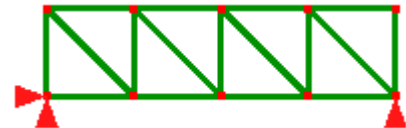

Step 7

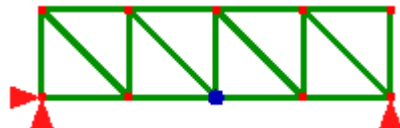

Select this node.

Right click  **Loads & Constraints** then select **New force**
Y

Table	select
	0,0
	0.01,-1
	0.49,-1
	0.5,0

Step 10



Click to solve the model.

The results are listed in the outline tree below **Solution**.

Click the play/pause button in the timeline to view the dynamic response of the structure.

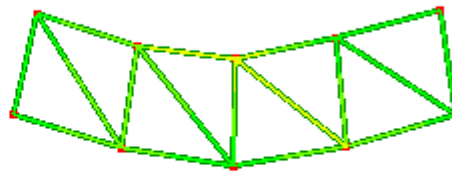
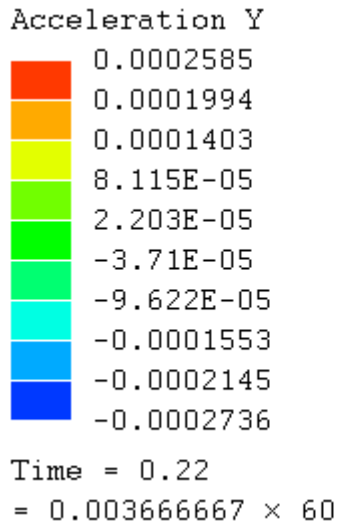

Modal response analysis does essentially the same thing as dynamic response analysis but should only be used for very small models (<1000 nodes) as it may run too slowly or run out of memory. The following elements - beam, wedge, pyramid, quadratic tetrahedrons and quadratic hexahedrons can be used for modal response. These element types are not available for use with dynamic response analysis.

3.5 Magnetostatic analysis of a current carrying wire

The magnetic field around a single copper wire carrying a current will be modeled. The wire is perpendicular to the screen with the current flowing outward. The wire is of diameter 0.025 m and the current 30 A.

$$B = \mu \times I / (2\pi R)$$

B = magnetic field

μ = permeability constant

$$\mu = 1.26 \times 10^{-6} \text{Tm/A}$$

R = radius

The magnetic field at a radial distance of 0.05m is required to be determined

$$BR = 1.26 \times 10^{-6} \times 30 / (2 \times 3.14 \times 0.05) = 0.12 \text{ mT}$$

Step 1

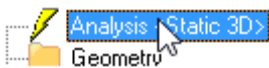

Right click, **Edit**. Select **2D**, then select **Magnetostatic 2D**
Permeability of free space 1.2566E-06

Step 2

The wire cross-section and the air surrounding the wire will be meshed using a template.

Mesh tools->Create->Circular plate

Ro 0.1
Quadrants select all
Concentric nodes select

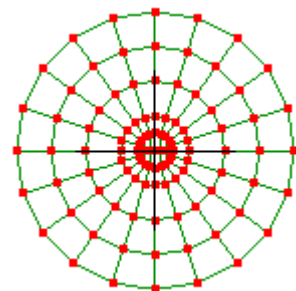

Click the Z arrowhead  to view the XY plane parallel to the screen.

Step 3

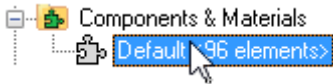

Right click, **Assign new material**
Electromagnetic tab
Magnetic permeability 1

Step 4

Activate select faces 

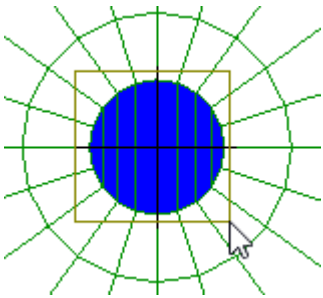

Drag to select the surfaces of the elements at the center within a radius 0.0125. These elements belong to the wire.

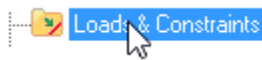

right click, **New current** type a value of 30 in the text-box.

Step 5

Activate select nodes 

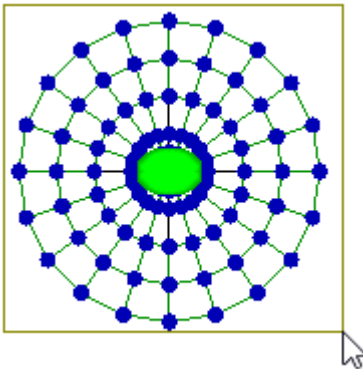

Drag to select all the nodes.

Edit->Circle selection

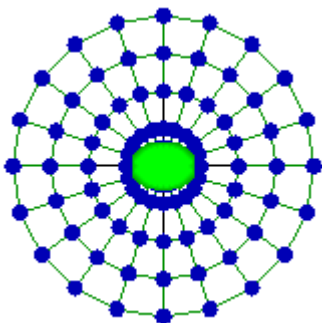

Hold the **Ctrl** key down and also the **Shift** key. Then click the center and drag to just before the nodes of the outer diameter.

The **Ctrl** key has the effect of preventing nodes that are already selected from becoming deselected. And the **Shift** key will prevent the center node from being dragged by the mouse.

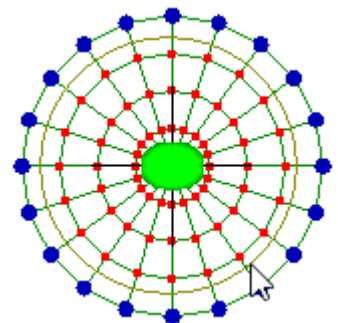

Activate select faces 

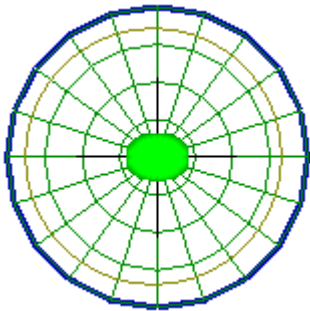

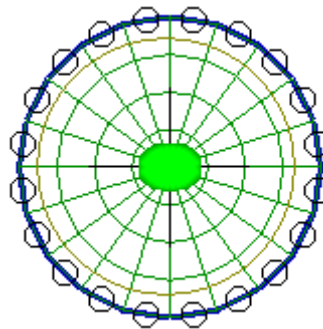

The node selection turns into a selection of the outer-diameter faces of the elements.

Right click on  **Load & Constraints** select **New magnetic vector potential**, accept the default 0 value.



Step 6

Click  to solve the model.

The results are listed in the outline tree below **Solution**. Click  **|B|**

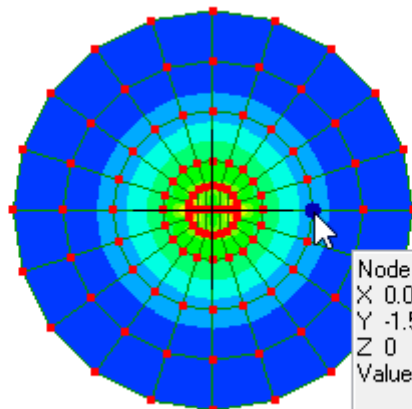
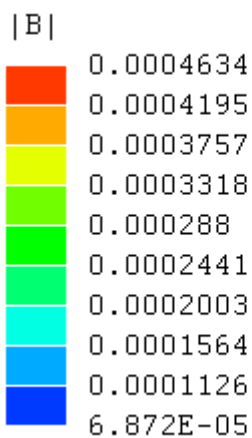

Node 3
X 0.05
Y -1.530758E-18
Z 0
Value 0.00012749394517551

Click node three which is at a radial distance of 0.05.

The value of the magnetic field at this distance matches the expected value.

3.6 DC circuit analysis

The following circuit will be solved for the voltage drop across the resistances, and the currents.

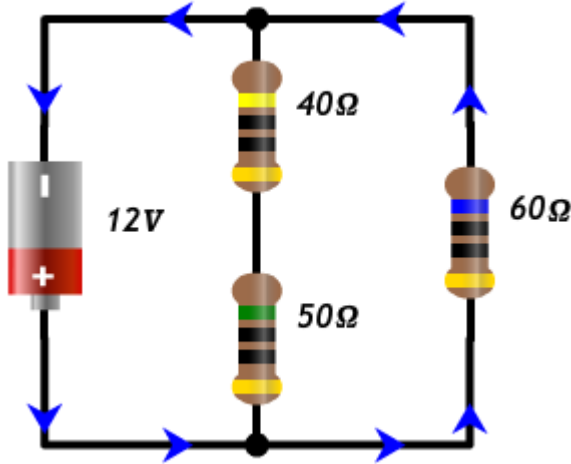

Current flowing through the 40Ω and 50Ω resistors is

$$12V / (40\Omega + 50\Omega) = 0.13A$$

Current flow through the 60Ω resistor is $12V / 60\Omega = 0.2A$

The voltage drop across the 40Ω resistor is $0.13A \times 40\Omega = 5.3V$

Voltage drop across the 50Ω resistor is

$$0.13A \times 50\Omega = 6.7V$$

Voltage drop across the 60Ω resistor is 12V

Step 1

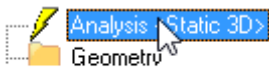

Right click, **Edit**. Select **3D**, then select **DC Current Flow**.

Step 2

Click the Z arrowhead  to view the XY plane parallel to the screen.

Click the **Polyline** tool  and click to form the following two line elements.

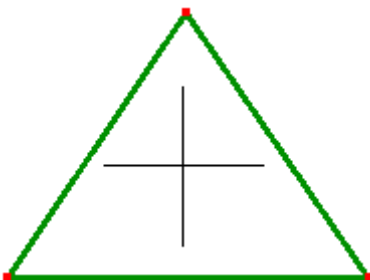
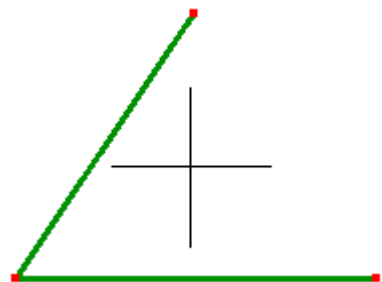

Click the **Close shape** button to complete the model.

Step 3

As each element has a different resistance, they need to be separate entities in the **Components & Materials**.

Activate select elements 

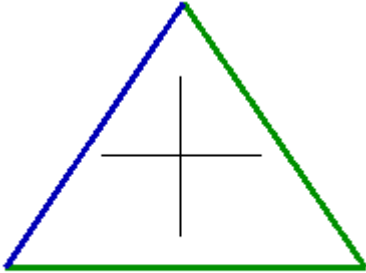

Right click on the selected element and select **Add elements to new component**

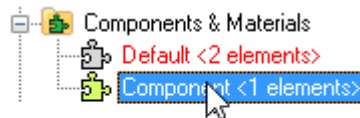

Right click on the new component and select **Assign new material**.
Electromagnetic tab
Extensive Resistance select 40

Repeat this step for the second element.

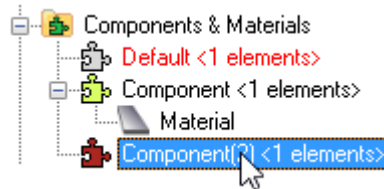
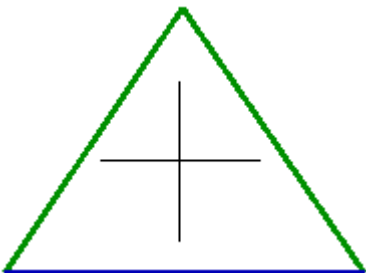

Electromagnetic tab
Extensive Resistance select 50

As there is only one element left in the **Default** under **Components & Materials**, right click to **Assign a new material**.

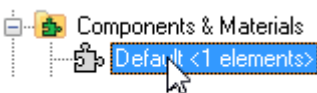

Electromagnetic tab
Extensive Resistance select 60

Step 4

Activate **Select nodes** 

Right click on this selected node then select **Loads & constraints** -> **New voltage** type 0 in the text-box.

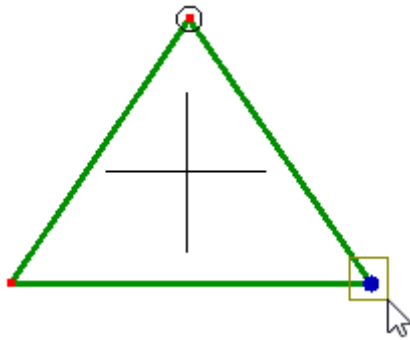
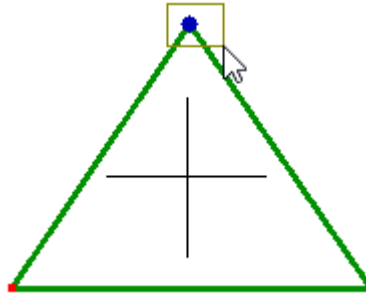

Right click on this selected node then select **Loads & constraints** -> **New voltage** type 12 in the text-box.

A 12V voltage has now been applied to the circuit.

Step 5

Click  to solve the model.

The results are listed in the outline tree below **Solution**.

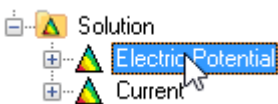

Select one of the field values and then click a node for a read-out of that value.

The sign of a current indicates its direction. If it is +ve, the current is flowing in the direction in which you formed the element going from the first node of that element to the second node. If the value is -ve, current is flowing in the opposite direction from the second node to the first.

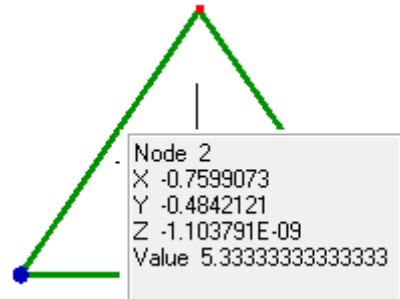

For the currents use the  **Table** to check the currents at the nodes instead of the graphics display of node averaged values. Nodal averaging can be misleading, for example the -0.2A in the 60Ω resistor averaged with the 0.1333A in the 40ohm resistor gives a non-existent 0.03333A.

3.7 Electrostatic analysis of a capacitor

The electric field between a simple two plate capacitor will be modeled. The plates are 0.005 m apart with air in between, and a potential difference of 1.5V.

The expected electric field, $E = \text{potential difference} / \text{distance between plates}$

$$E = 1.5 / 0.005 = 300 \text{ V/m}$$

Step 1

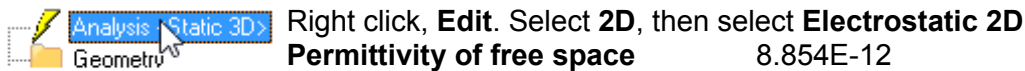

Step 2

Click the Z arrowhead  to view the XY plane parallel to the screen.

Mesh tools->Create->Node...

X 0
Y 0
Z 0

A red dot appears at the origin.

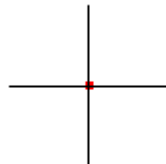

Add more nodes using the following coordinates.

(0.015,0,0)
(0.015,0.005,0)
(0,0.005,0)

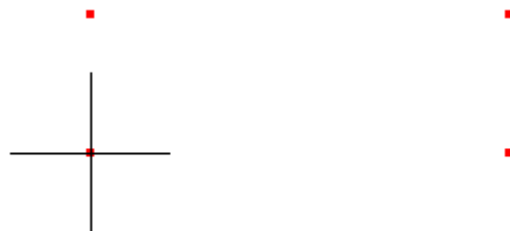

Use the **Fit to screen**  to display the nodes

Step 3

In this tutorial the area between the two plates of the capacitor will be defined using two node line elements, and then the 2D automesher will then be used to fill the region with quadrilateral or triangle elements.

Mesh tools -> Create > Element... Select **line2** and click the four nodes to form the area between the two plates.

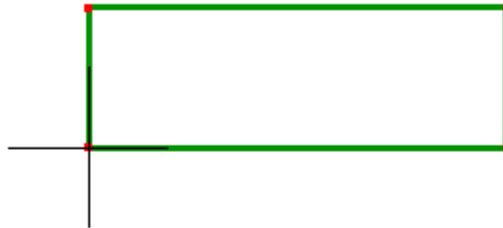

Step 4

Mesh tools->Automesh 2D...
Maximum element size
accept the rest of the defaults

0.001

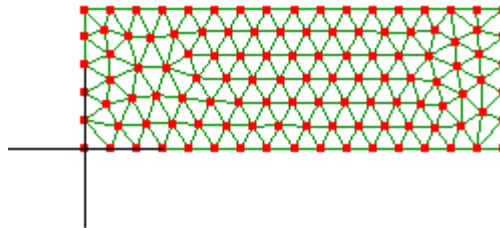

Step 5

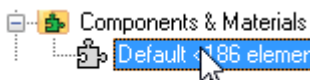

Right click, **Assign new material**

Geometric tab

Thickness 1

Electromagnetic tab

Isotropic select

Relative permittivity 1

Step 6

Activate **Select nodes** 

Drag to select the nodes at the top.

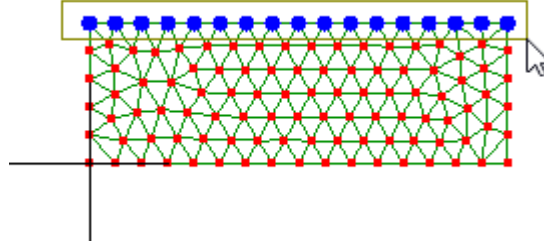

Activate select faces 

The element faces will become selected. Although they appear to be edges, in reality they are faces normal to the screen because of the thickness dimension that is not displayed.

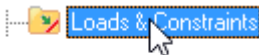
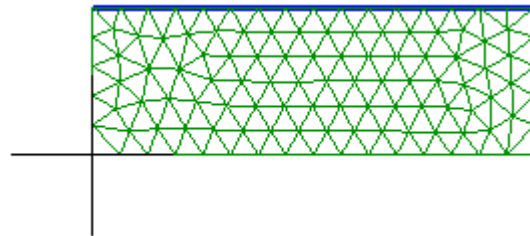

While the faces (edges) are selected, right click on **Loads & Constraints** then click **New voltage**. Type 1.5 in the text-box.

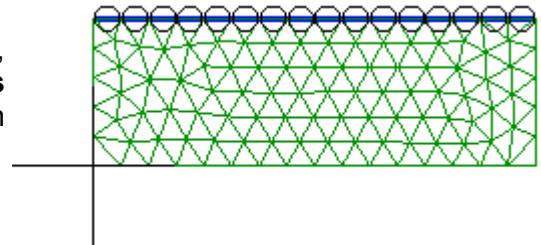

Activate **Select nodes** 

Drag to select the nodes at the bottom.

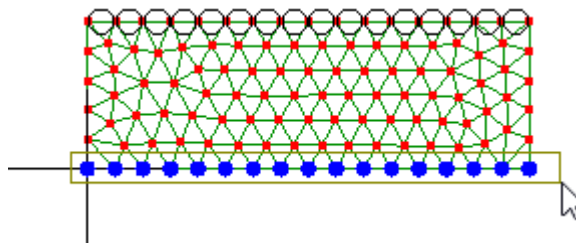

Activate select faces 

The element edges will become selected.

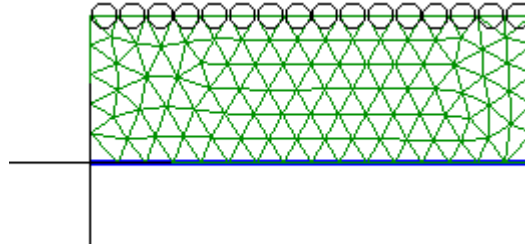

While the edges (faces) are selected, right click on **Loads & Constraints** then click **New voltage**. Accept the default 0 value.

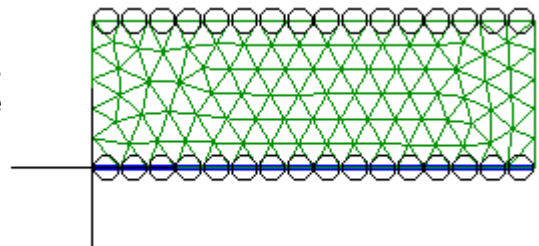

Step 7

Click  to solve the model.

The results are listed in the outline tree below **Solution**. Click  **Electric Field Magnitude**

Electric Field Magnitude

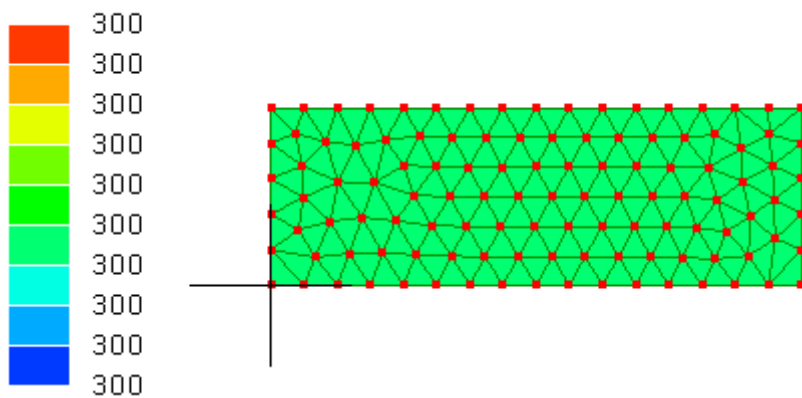

This matches the expected value of 300 V/m.

3.8 Acoustic analysis of an organ pipe

We will predict the musical note produced by an 8 ft (2.4384m) long 'open wood' organ pipe. An actual pipe would be rectangular in section, but here we make only a 2D model. The pipe will be 120 mm wide with a 30 mm mouth at one end where air is blown in, and an opening at the other end for the air to exit. The wood is 10 mm thick.

In acoustic analysis the air within the pipe needs to be meshed and not the pipe itself. The mesh needs to include a large volume of the air in the room outside the pipe which is connected to the mouth and the open end. This scheme allows LISA to model leakages and openings. We are interested only in the resonant modes of the organ pipe, but LISA will also predict resonances in the air outside. An important part of this case study, therefore, is to show how some understanding of the physics is required in order to interpret the results and identify the appropriate modes.

A rough calculation will be made for the expected frequency.

An end correction factor must be added to the length of the pipe. This correction factor is equal to the width of the pipe. So the effective length of the pipe is $2.4384 + 0.12 = 2.5584$

When 1/2 a wavelength fits into the pipe it will be of length $2 \times 2.5584 = 5.1168$

The velocity of sound in air at 18°C is 342 m/sec, so the expected frequency will be $\text{velocity/wavelength} = 342/5.1168 = 66.84 \text{ Hz}$.

Step 1

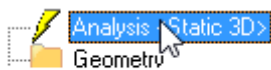

Right click, **Edit**. Select **2D**, then select **Acoustic Cavity Modes 2D**
Number of modes 20

To ascertain the fundamental pitch we need to examine the results for a number of pitches. We will also look at harmonics.

Step 2

Mesh tools->Create->Node...

X 0
Y 0
Z 0

The node appears as a red dot at the origin.

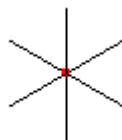

If you don't see the node make sure you've activated the node select mode 

Click the Z arrowhead  to view the XY plane parallel to the screen.

Add more nodes using the following coordinates. Dimensions are in meters.
(2.4384,0,0)
(2.4384,0.12,0)
(0,0.12,0)

Use the **Fit to screen**  to display the nodes.



Step 3

You will have to zoom-in to see the nodes. Drag to select the nodes on the left.

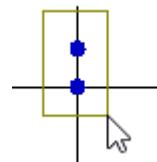

Mesh tools->Move/copy...

X -2.0

Copy select



Select the same nodes

Mesh tools->Move/copy...

X -0.01

Copy select



You will have to zoom-in to see these nodes.

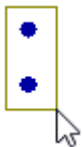

Drag to select the nodes on the very right.

Mesh tools->Move/copy...

X 2.7

Copy select



Step 4

Drag to select the following nodes



Mesh tools->Move/copy...

Y 0.8

Copy select



Drag to select the following nodes



Mesh tools->Move/copy...

Y 0.01

Copy select

These nodes will be too close together so you will have to zoom-in to see them.



Drag to select the following nodes

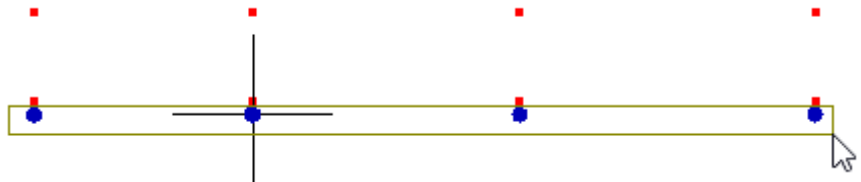

Mesh tools->Move/copy...

Y -0.6

Copy select



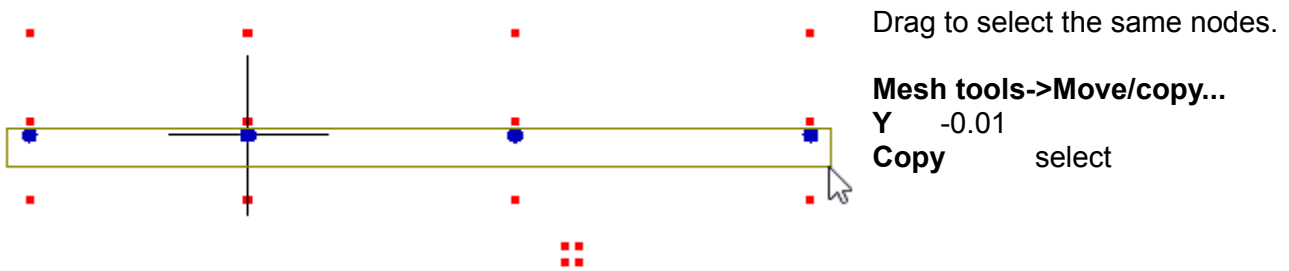

A zoomed-in view shows these nodes.

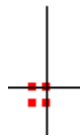

Step 5

Activate select nodes 

Mesh tools->Create->Element... Select **quad4 plane** and click four nodes to form the following pattern of quadrilaterals. The order of the clicked nodes will affect the orientation of the mesh refinement that will be done in the next step. In this tutorial the elements have been formed by going counter-clockwise starting with the node at the lower left corner.

- 23,24,29,28
- 28,29,7,5
- 5,7,8,6
- 6,8,19,18
- 18,19,14,13
- 24,21,26,29
- 19,17,12,14
- 17,16,11,12
- 1,2,3,4
- 21,22,27,26
- 22,25,30,27
- 27,30,9,2
- 2,9,10,3
- 3,10,20,16
- 16,20,15,11

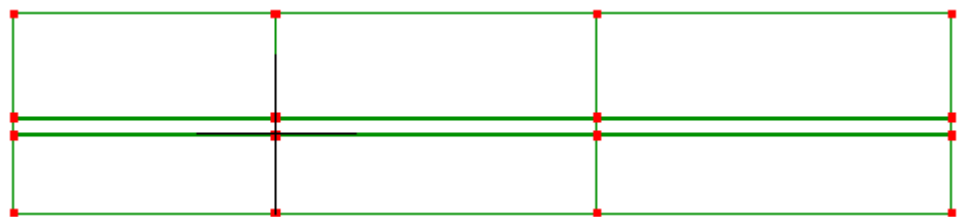

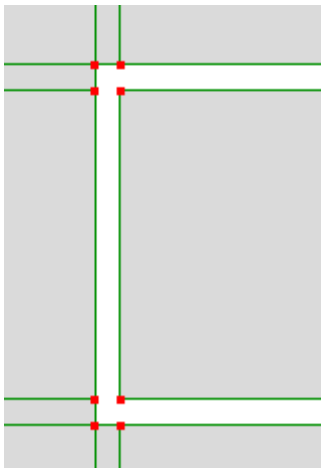

The zoomed-in view shows the white areas where no elements are present, representing 0.01 m pipe thickness.

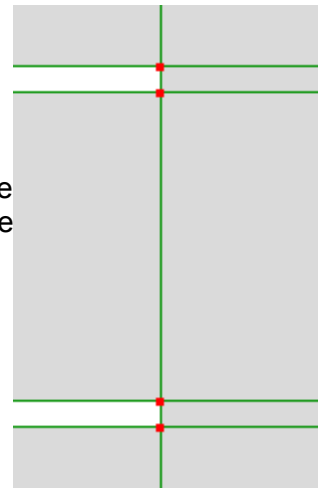

Step 6





Right click and select **Assign new material**
Mechanical tab
Isotropic select
Speed of sound 342

Step 7

Activate select elements 

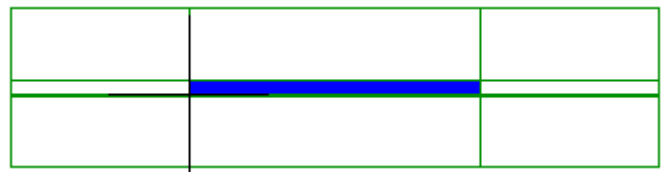
Select the element in the center. This will be the air in the organ pipe.



Right click  **Components & Materials** select **New component**

Step 8

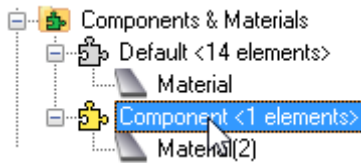

Right click and **Rename** it to Pipe air. Notice how LISA assigns a different color to it. You can right-click again to select a **Color** of your choosing.

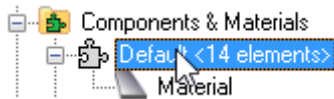

Right click and **Rename** it to Room air.

Step 9

We now refine the mesh through several stages.

Click on the Pipe_air component to select its element.

Mesh tools->Refine->Custom...

R 120

S 2

If you find the subdivisions are in the wrong direction **Ctrl+Z** to undo and use 2 for **R** and 120 for **S**.

While still in the select elements mode, select the larger room air elements. Hold the **Ctrl** key down so that the first selected element does not become deselected when you click the second element.

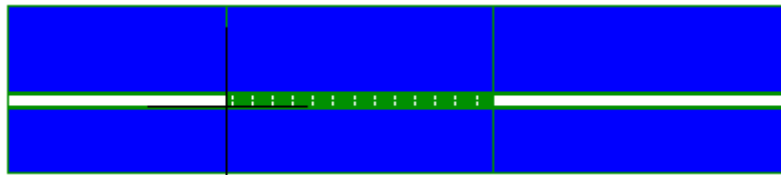

Mesh tools->Refine->Custom...

R 20

S 3

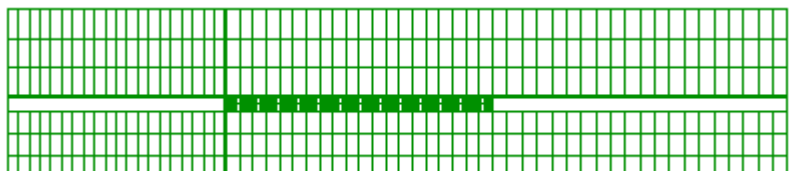

Select this element

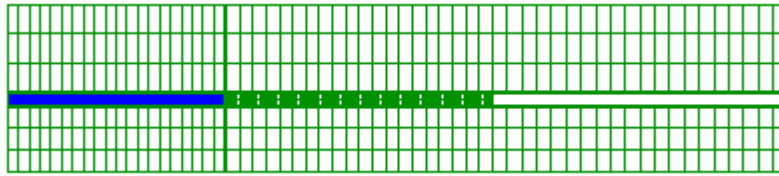

Mesh tools->Refine->Custom...

R 20
S 1

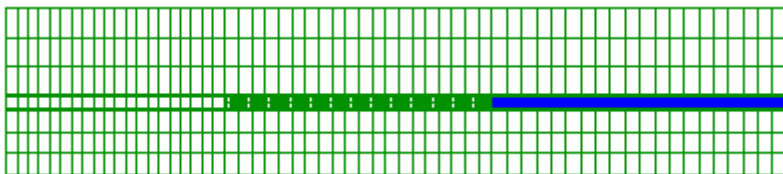
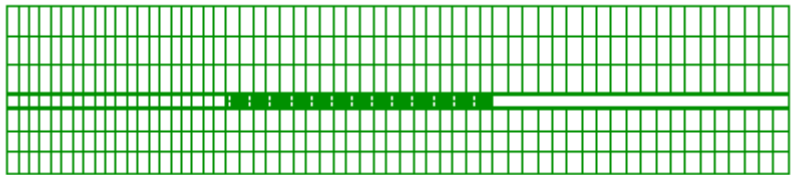

Select this element.

Mesh tools->Refine->Custom...

R 20
S 2

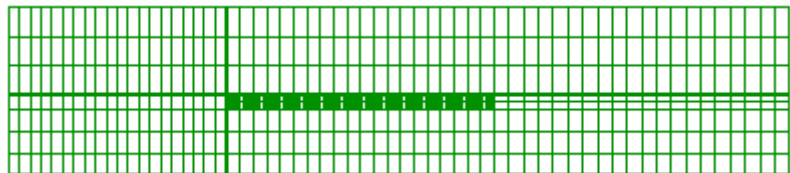

Select these four elements.

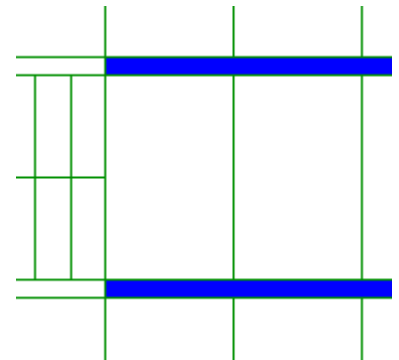
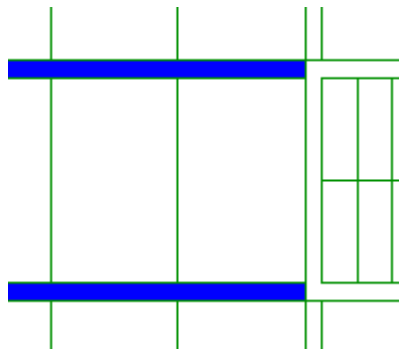

Mesh tools->Refine->Custom...

R 20

S 1

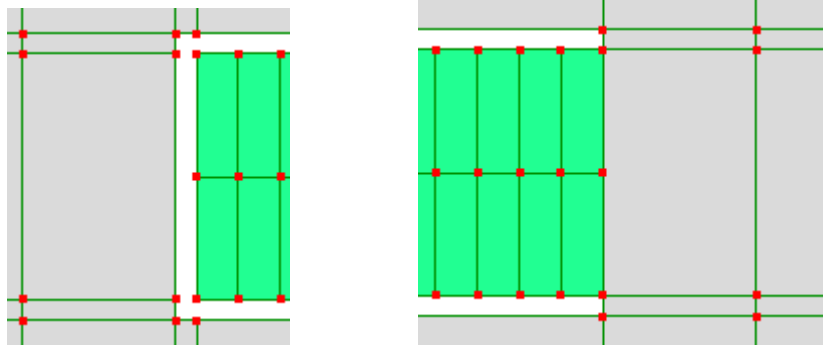

Select these two elements

Mesh tools->Refine->Custom...

R 1

S 3

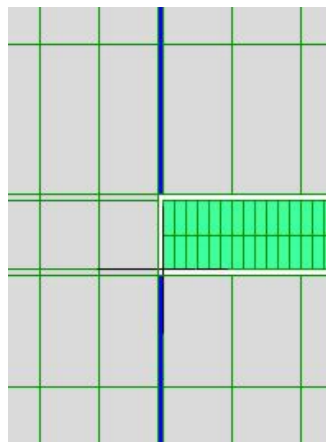



Select this column of elements just outside the open end of the pipe. We need refinement here because some air immediately outside the pipe will also vibrate.

Mesh tools->Refine->Custom...

R 4

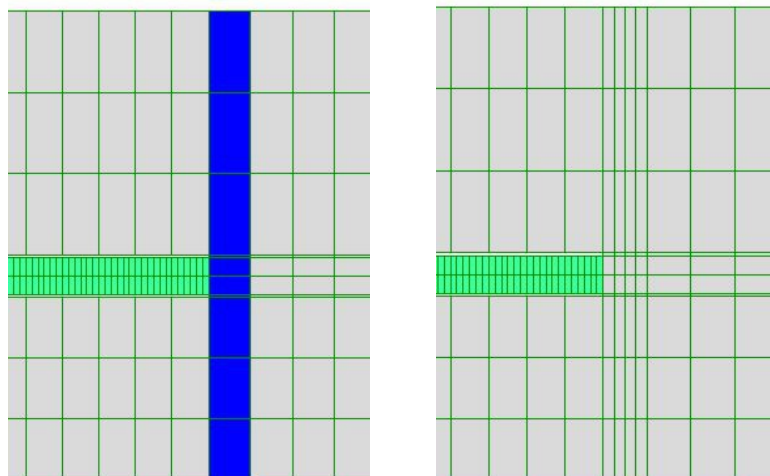
S 1



Now zoom in on the left hand end of the pipe. Activate select faces 

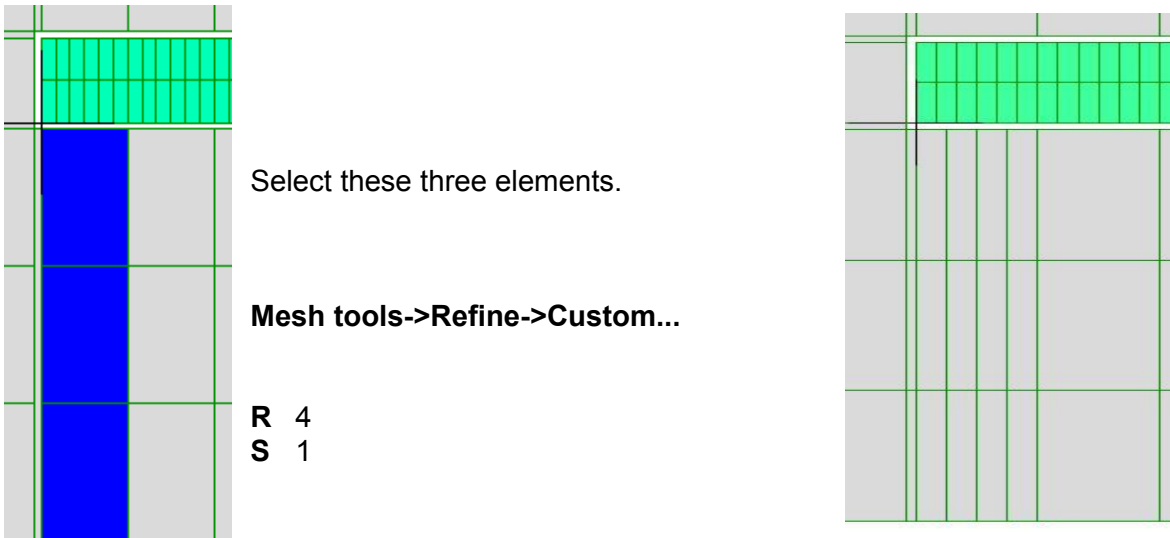

That completes the refinement. Your model should now look like this:

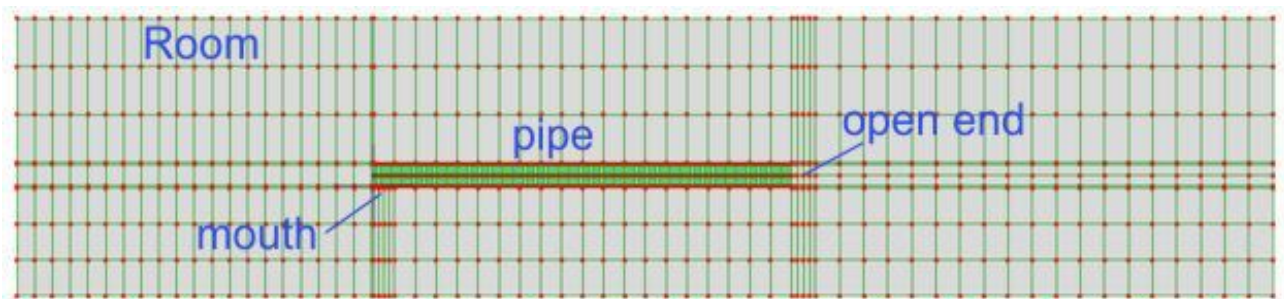



Step 10

This is a good stage to connect up all the elements. (If you select **View->Open Cracks**, you will see many gaps.) Use the tape measure tool-button  to confirm that the smallest distance between the nodes is 0.01. Use the tape measure tool by clicking and dragging from one node to another. Right click to exit the tape measure tool. Then, select **Mesh Tools->Merge nearby nodes** and type a value of 0.005. Check again with **View->Open Cracks**.

Step 11

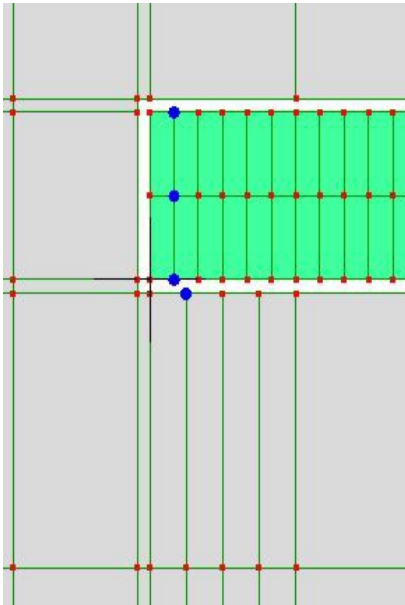
The air in the pipe is currently connected to the air in the room only at its open end. The end with the mouth now needs to be connected to the air in the room. The mouth is open 0.03 m.



Zoom-in to  view the left end of the pipe air elements. Activate select nodes  then select these four nodes. Right click on the selected nodes, then select **Node coordinates** and change **X** to 0.015.

Select the four nodes to the right of the previously selected nodes and then the **X** to 0.03.

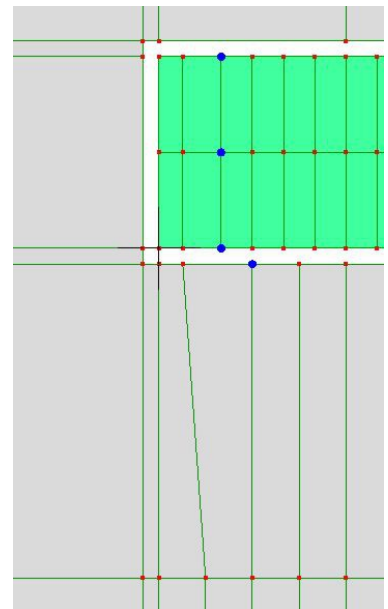

Activate select nodes 

To connect the air in the pipe with the air in the room at the lip use the **Mesh tools -> Create > Element..** Select **quad4 plane** and click the nodes to create the following two quadrilaterals.

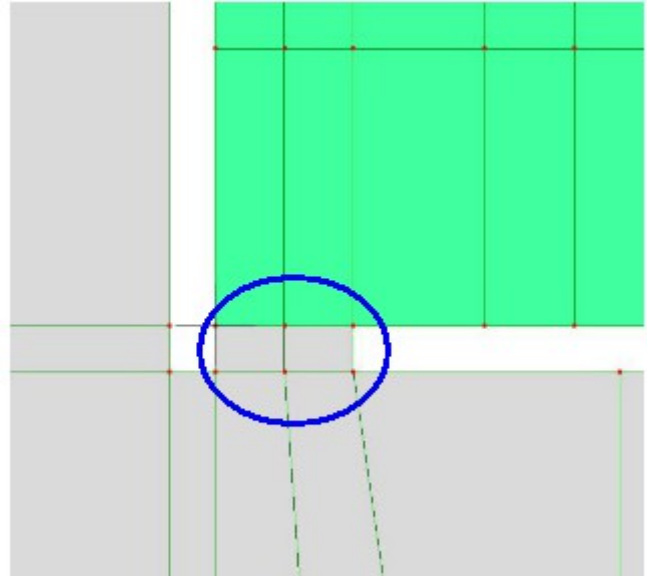

Step 12

The mesh needs to be refined just outside the mouth. Any localized mesh refinement must produce only quad4 elements that correctly connect with the adjacent elements node-to-node, as nodes cannot be connected to element edges.

Activate select faces 

Select these three elements.

Mesh tools->Refine->Custom...

R 1

S 3

View->Open Cracks will show that this operation has left the newly created elements disconnected from the adjacent elements of the existing mesh.

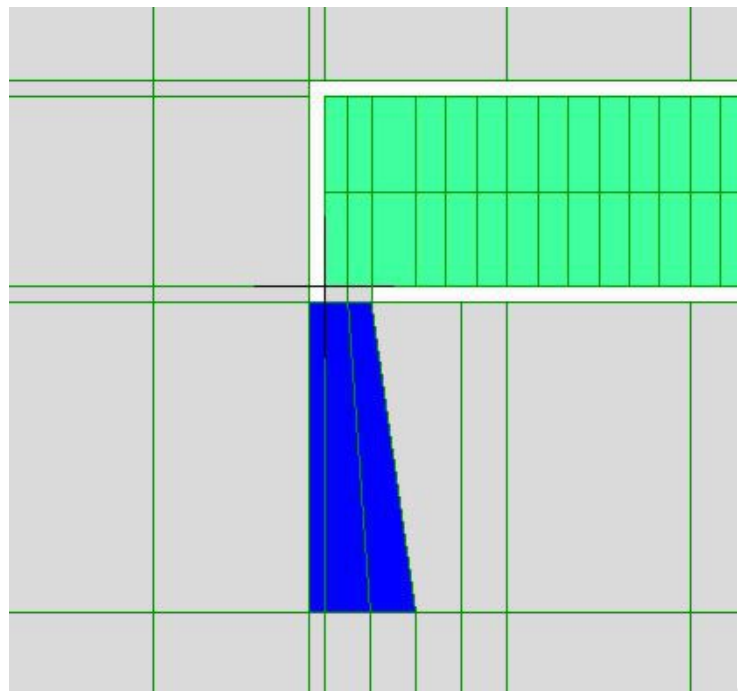

Activate select nodes 

Select these two nodes.
Mesh tools -> Insert node between

Now click the new node to select it.

Mesh tools -> Move/Copy...

Copy selected

Y 0.02

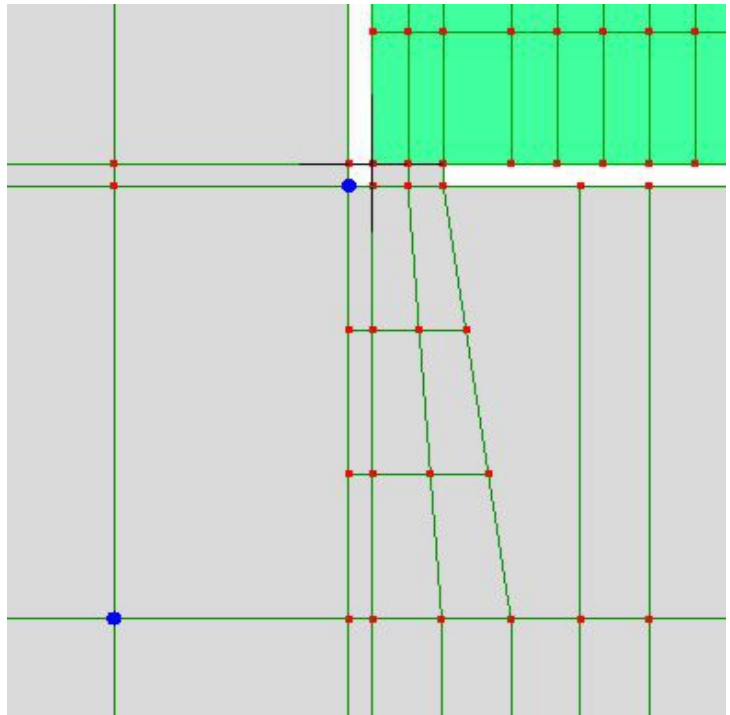

Activate select faces 

The two nodes will be hidden.

Select the element with the two new nodes in the middle and delete it.

Activate select nodes 

The two nodes will be displayed.

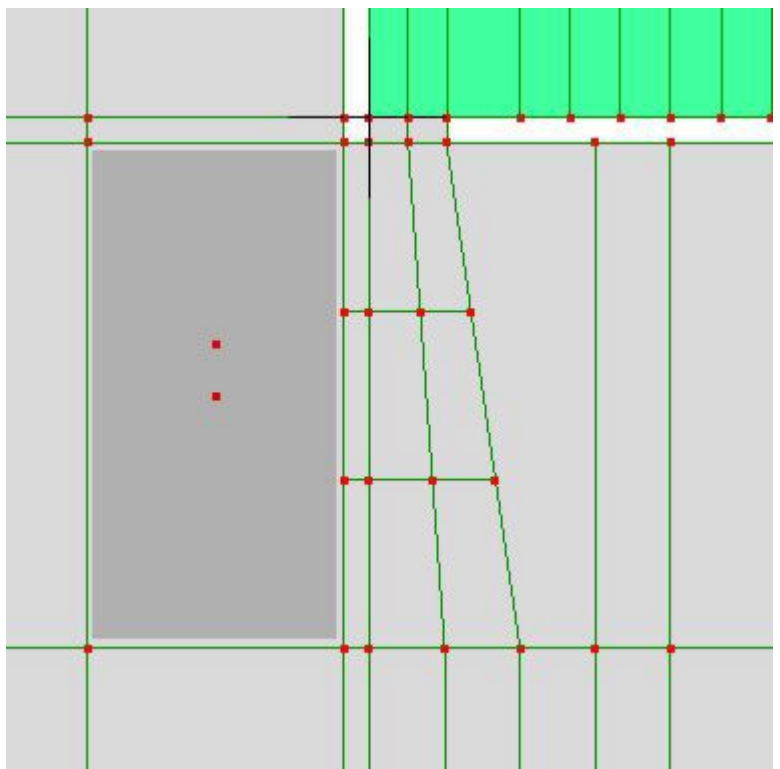

Mesh tools ->Create Element... select quad4 plane

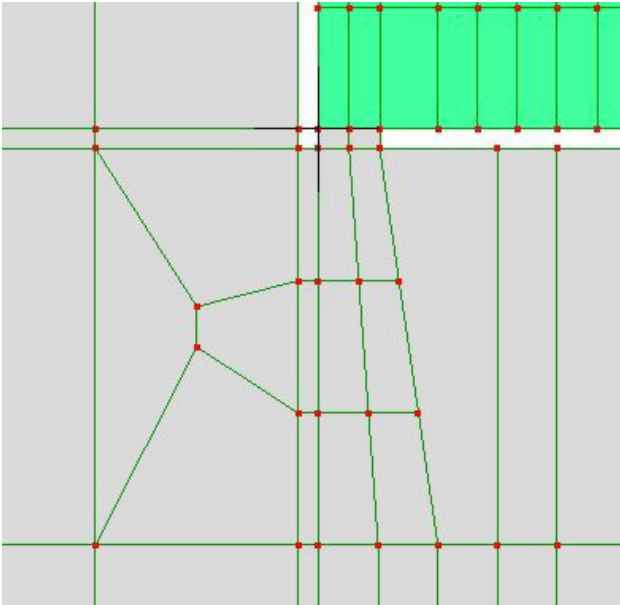

Click the nodes to form the four quadrilateral elements shown filling the area left behind by the deleted element.

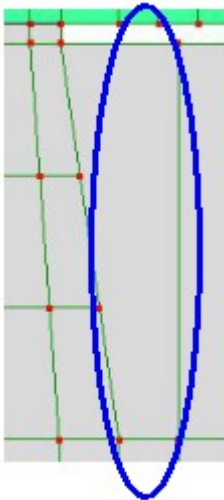

Likewise, delete this element on the other side of the lip.

And again, fill the space with quadrilateral elements.

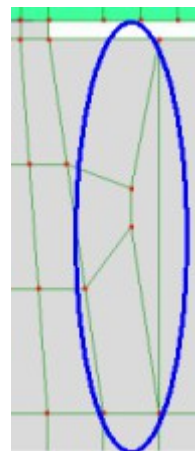

Check with **View->Open Cracks**

Step 13

The mesh building is now complete so click to  solve the model.

The modal frequencies are listed in the outline tree below **Solution**. Click the nodes for a read-out of the field value there.

The subtlety in this case study is in interpreting the results. From the 20 calculated modes we want to pick out the fundamental pitch of the pipe itself. Click through the various modes and observe that most show red, yellow and blue patches for the room air elements.

The 5th mode at 66.56 Hz is different because the 'room' is almost constant color (blue). Zoom in on the pipe, and notice that the maximum pressure value of the pipe air elements is 2.391, much higher than for any of the other modes. This identifies mode 5 as the fundamental pitch of the pipe organ. Half a wavelength fits inside the pipe. The frequency matches the hand calculated value very well.

Pressure

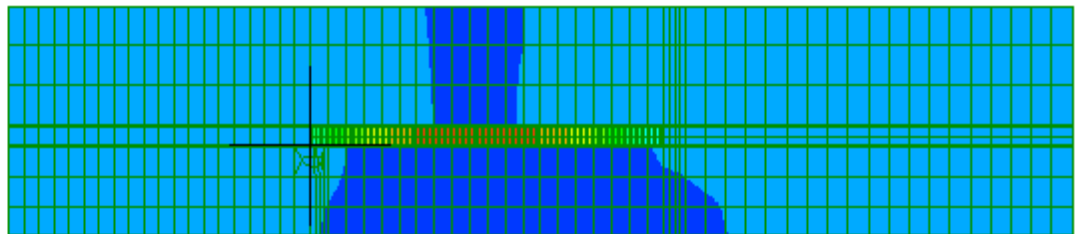
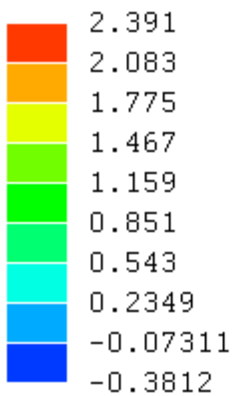

Angular freq. = 418.1909

Frequency = 66.55715

Similarly Mode 12 at 133 Hz has an almost constant green color in the room and high, variable pressure in the pipe. This is the first harmonic at almost exactly twice the frequency, sounding one octave higher. A full wavelength fits inside the pipe.

Pressure

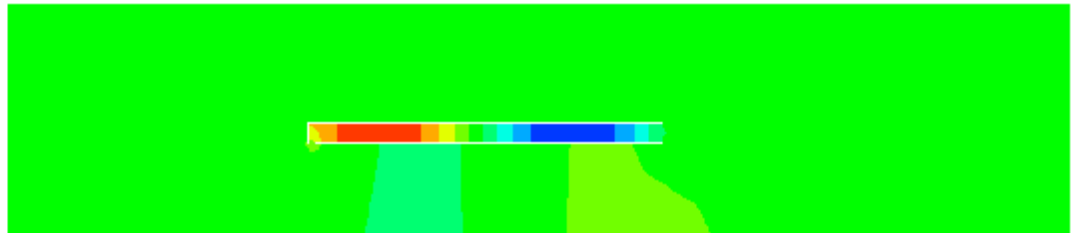
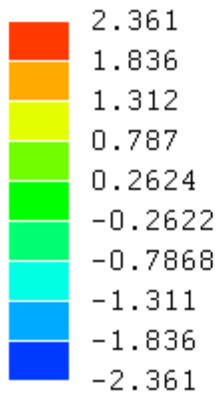

Angular freq. = 836.0082

Frequency = 133.0548

Mode 20 at almost 200 Hz is the third harmonic.

Pressure

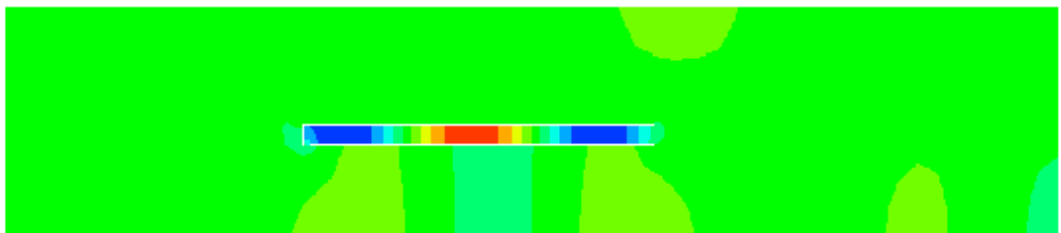
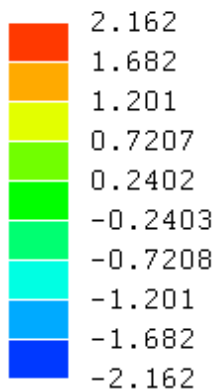

Angular freq. = 1255.698

Frequency = 199.8505

Step 14

As an exercise we will investigate the stability of the solution to a change in the size of the room.

Select some nodes in the room to the right of the pipe, and use **Mesh tools -> Scale...** type 1.5 to scale the Y-co-ordinate. This enlarges part of the room without disturbing the pipe. The precise nodes and scale value used do not matter, so try several variations.

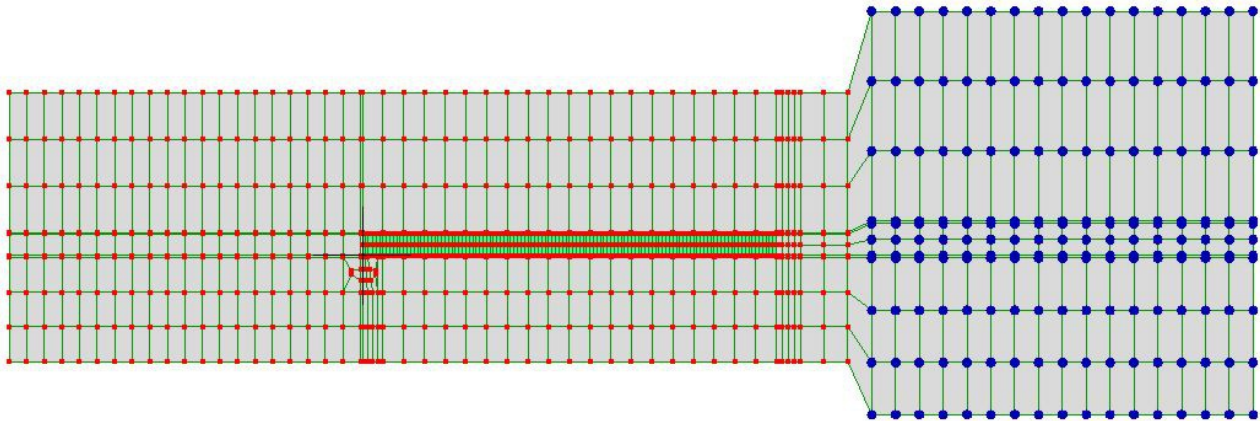

Run the solver again and observe that all the room modes change in frequency, but the pipe-only modes vary hardly at all from about 66 Hz and 133 Hz.

Step 15

Finally, investigate the effect of closing the open end of the pipe by selecting these four elements which lie immediately outside the open end. Press the **delete** key. This now isolates the air in the pipe from the air in the room at what was once the open end of the pipe.

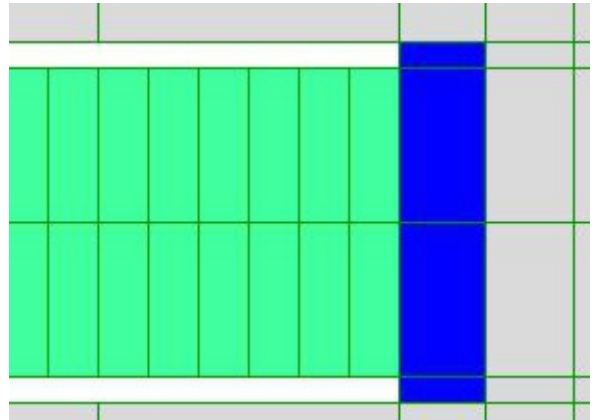

Run the solver. The fundamental frequency drops to 34 Hz (Mode 3), almost an octave lower than the open pipe, a fact well known to organists. The pipe now holds only one quarter wavelength – observe that the pressure at the mouth is almost that in the room.

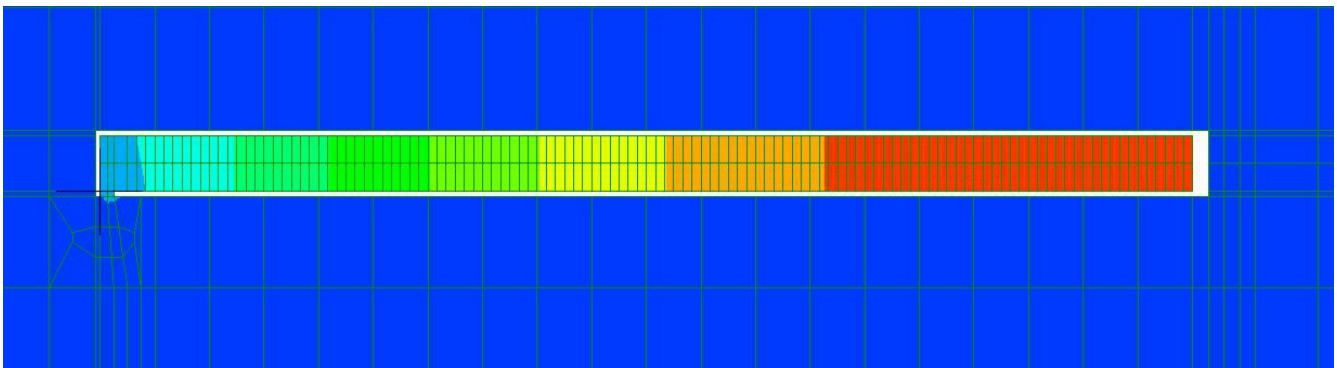

3.9 Buckling of a column

The eigenvalue buckling of a column with a fixed end will be solved. The column has a length of 100mm, a square cross-section of 10mm and Young's modulus 200000 N/mm².

The critical load for a fixed end Euler column is $\pi^2 EI / (4L^2)$

E = Young's modulus

I = moment of inertia

$$I = 10^4 / 12 = 833.33 \text{mm}^4$$

L = length

$$\text{Critical load} = \pi^2 200000 \times 833.33 / (4 \times 100^2) = 41123.19$$

Step 1

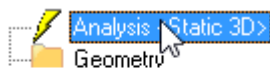

Right click, **Edit**. Select **2D**, then select **Buckling 2D Beam**.

Number of modes 3

Shift point 1

Step 2

Mesh tools->Create->Node...

X 0
Y 0
Z 0

The node appears as a red dot at the origin.

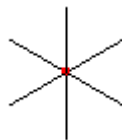

If you don't see the node, make sure you've activated the node select mode 

Add another node using the following co-ordinate.
(0,100,0)



Use the **Fit to screen**  to display the nodes.

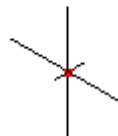

Step 3

Mesh tools -> Create > Element.. Select **line2 beam** and click the two nodes.



Step 4



Right click, select **Assign new material**

Geometric tab

General section	select
2nd moment of area about W	833.33
Cross sectional area	100

Mechanical tab

Isotropic	select
Young's modulus	200000

Step 5

Mesh tools->Refine->x2 or  repeat four more times.

To see the mesh refinement switch to the node select mode 



Step 6

Select this node then right click  **Loads & Constraints** and select **New force**. In the **Y** textbox type -1.

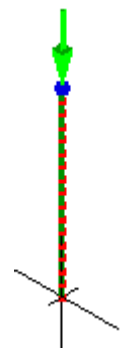
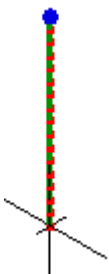

Step 7

Activate select nodes 



Select the node at the bottom then change to face selection mode 

Now the bottom end face is selected.

Right click  **Loads & Constraints** and select **New fixed support**

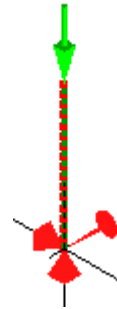

Step 8

Click  to solve the model.

The results are listed in the outline tree below **Solution**.

Click the animation tool-button  to view the buckling mode shape.

As the load used for the model was 1N, the load at failure is $1 \times 41123.27 = 41123.27$ N, which matches the hand calculated value.

Displacement Magnitude

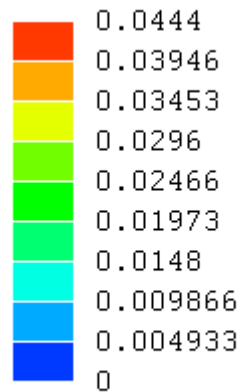

Buckling factor = 41123.27

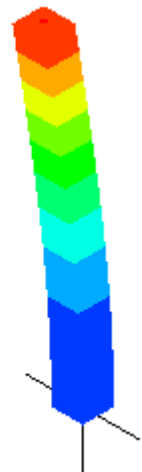

3.10 Fluid flow around a cylinder

A confined streamlined flow around a cylinder will be analyzed for the flow potentials and velocity distributions around the cylinder. The inward flow velocity is 1 m/s . The ambient pressure is 1×10^5 Pa, density 1000 kg / m^3 .

Step 1

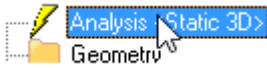

Right click, **Edit**. Select **2D**, then select **Fluid Potential Flow 2D**
Ambient pressure 1E05

Step 2

Mesh tools->Create->Create curve generator... select **Circle/ellipse**

D1 8
D2 8

Click the Z arrowhead  to view the XY plane parallel to the screen.

Use the **Fit to screen**  to display the elements.

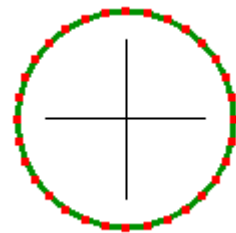

Step 3

Mesh tools->Create->Node...

X -20
Y 8
Z 0

If you don't see the node, make sure you've activated the node select mode 

Add more nodes using the following coordinates.

(20,8,0)
(20,-8,0)
(-20,-8,0)

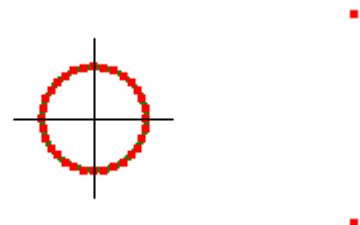

Step 4

Mesh tools -> Create > Element.. Select **line2** and click the four nodes to form the outer boundary.

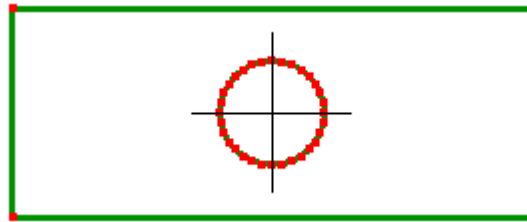

Step 5

Mesh tools->Merge nearby nodes...

Distance tolerance 0.001

Mesh tools->Automesh 2D...

Maximum element size 1.5

Quad dominant select

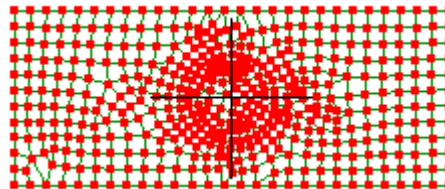

Step 6

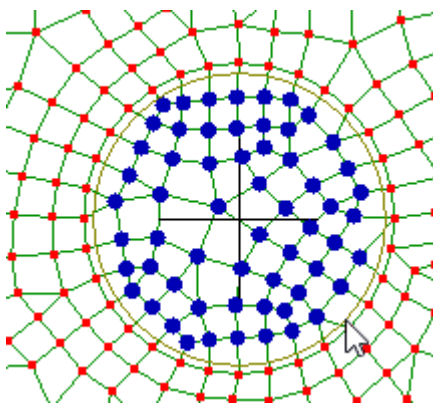

Edit->Circle selection

Drag to select the nodes inside of the 8 diameter.

Press the **delete** key.

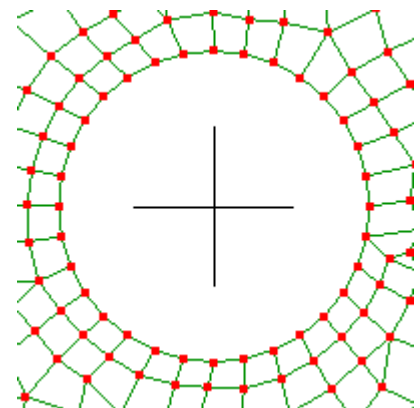

Step 7

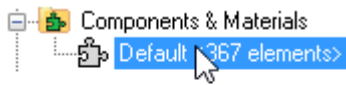

Right click, **Assign new material**
Geometric tab select **plate/shell/membrane**
Thickness 1

Mechanical tab
Isotropic select
Density 1000

Step 8

Activate select nodes

Edit->Rectangle selection

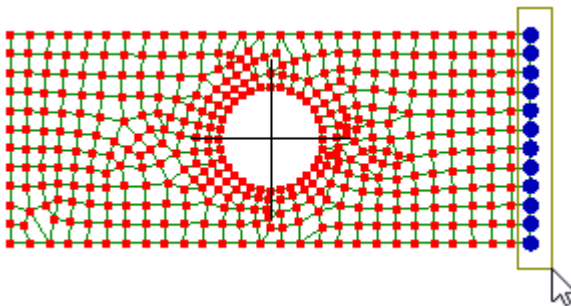

Select the nodes on the right edge.
Right click then select
On selected nodes->New velocity potential
Value 0

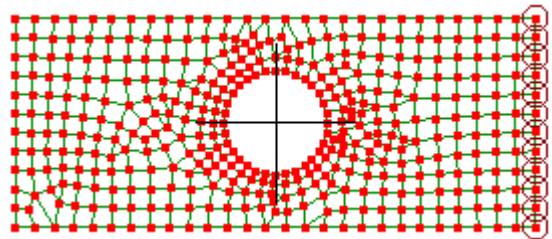

Step 9

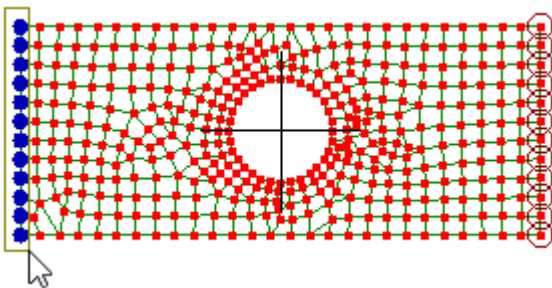

Drag to select the nodes on the left edge

Switch to select faces

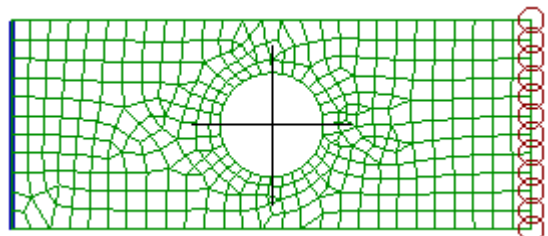

Right click  **Loads & Constraints** then select **New flow rate** in the text-box type 1.

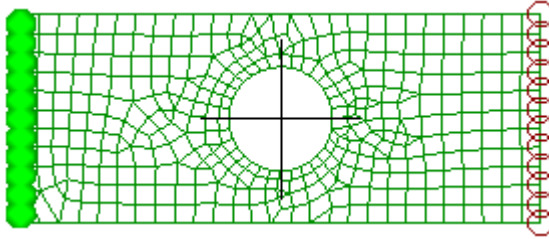

Step 10

Click  to solve the model.

The results are listed in the outline tree below **Solution**. Click  **Velocity Magnitude**

Click  to visualize the flow.

Velocity Magnitude

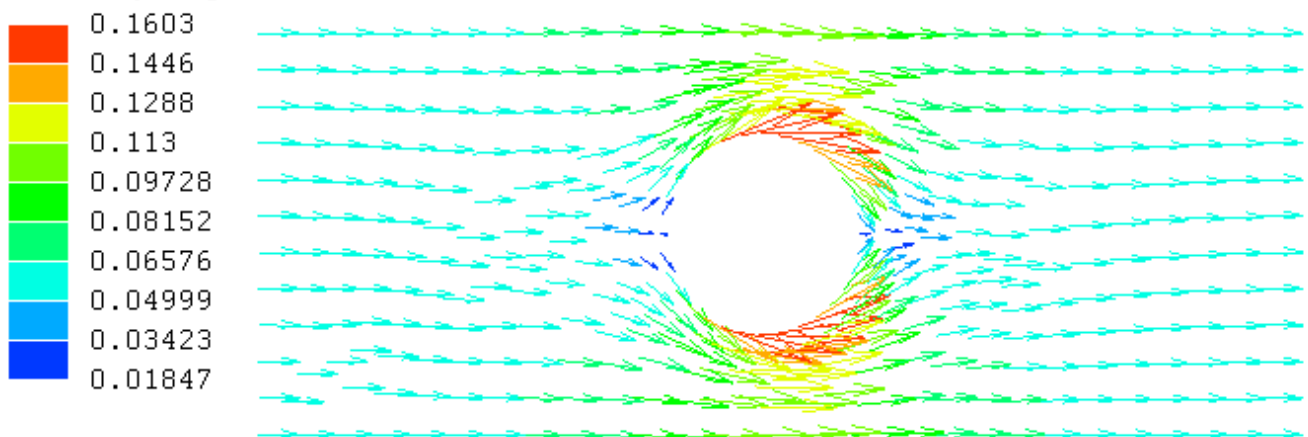

That concludes our overview of the types of analysis which LISA can carry out. Bear in mind that static analysis can generally be done using orthotropic or anisotropic materials such as wood or carbon fiber composites, as well as the more familiar isotropic materials.

Modeling Tutorials

This chapter contains three advanced examples of building a mesh in LISA. As you work through them, you will gain greater skill and confidence in using the individual meshing tools, and also develop a wider understanding of how to plan a model-building project. Important strategies include starting with the most complicated features first, using component symmetry, saving intermediate stages under different file names in case you have to back-track, and running the program at intermediate stages (perhaps with dummy data) to check that the **Solver** will run. Complex objects can be modeled as a number of separate components, in separate LISA files, and assembled later by importing them into one final LISA file.

4.1 Tapers, rectangle and V shaped cut-outs

Step 1

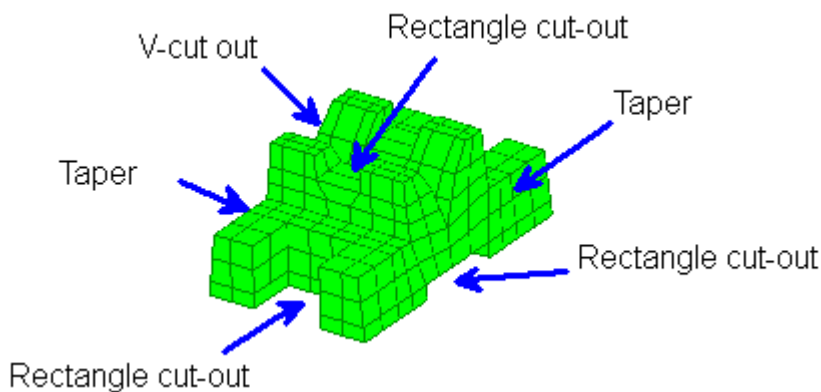

Identify the most difficult features and model them before the easier features.

For this part the V-cut out would be the first feature to model.

Step 2

Mesh tools->Create->Node...

X 0
Y 0
Z 0

Repeat for the following coordinates

0,0,20
0,3,20
0,3,40
0,0,40
0,0,60
0,13,60
0,13,43
0,25,43
0,25,38
0,11,31.5
0,25,23
0,25,18
0,13,18
0,13,0



Click to make view parallel to the screen.



Step 3

Nodes need to be located at precise locations for accomplishing the cut-outs of the other views not currently visible in this view.

Mesh tools->Create->Node...

0,0,49
0,13,49
0,13,11
0,0,11

These nodes are positioned ahead of time for a cut-out that will be done later.

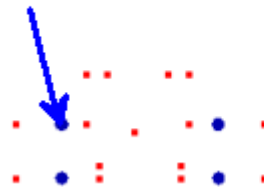

Step 4

This profile is simple enough to be composed of only quadrilateral elements. However, in order to do that, additional nodes need to be created so that complete quadrilaterals can be formed. Elements need to be connected node to node. If a node falls on an edge, there will be no connection and a gap or penetration will occur.

Select this node **Mesh tools->Move/copy...**
Y -8
Copy selected

Select these nodes **Mesh tools->Move/copy...**
Y -10
Copy selected

Step 5

Mesh tools->Create->Element...
quad4 shell

Click the nodes to form quadrilaterals. Do this going counter-clockwise starting from the lower left corner. This is only so that the particular template button shown in the next step works the same on your mesh.

Step 6

To make the element sizes about the same size as each other, use the **Mesh tools->Templates...**

Activate select faces 

Select all these faces. Hold the **Ctrl** key down to add to or remove from the faces that have already been selected.

Click this template.



Select these faces.

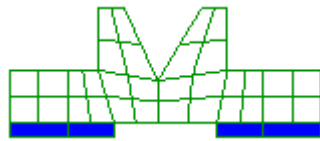

Then use this template.

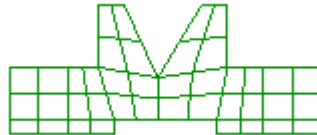

Depending on the order in which you clicked the nodes to form the elements the above tool-button might or might not have worked for you. If you formed the elements as instructed in the previous step to go counter-clockwise starting the lower left corner it would have worked. If you formed the elements any other way you will have to experiment with the available template patterns to get the mesh looking the same.

Step 7

Activate select faces 

Select the entire mesh.



Mesh tools->Extrude...

Direction	+X
Thickness	35
Number of subdivisions	7

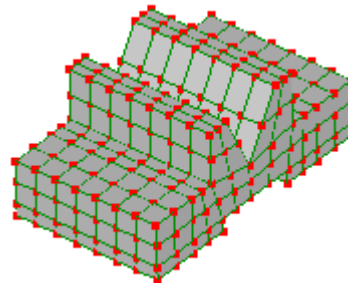

The number of subdivisions was chosen as 7 because we have to plan ahead for the 15 wide cut-out. By keeping each element $35/7=5$ wide, it will be a simple matter of deleting three rows of elements ($3 \times 5 = 15$) to obtain the cut-out.

If your extruded mesh looks strange **Ctrl+Z** to undo, and click in an open area to deselect everything then try it again.

Step 8

 Activate **Select elements**

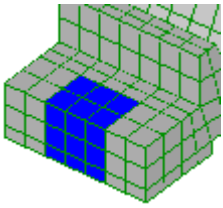

Hold the **Ctrl** key down and select the following elements. Then press the **delete** key.

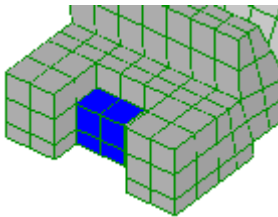
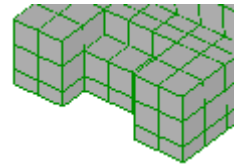

Select the elements that were inside and delete them as well.

That completes one cut-out.

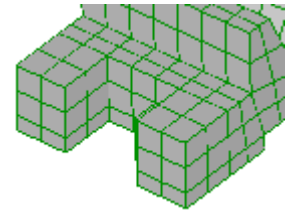

Step 9

Rotate the model into view and repeat the previous step to complete the second cut-out.

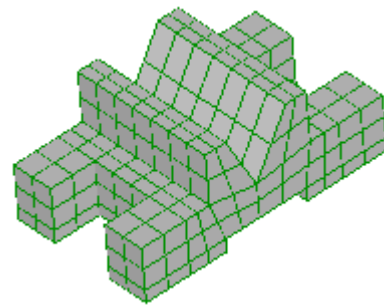

Step 10

We have to create the rectangular cut-out in the V-section, however, we forgot to plan ahead and place the nodes in position to make deleting the elements easy. You will have to re-set the coordinates of the relevant nodes now.

Activate select nodes 

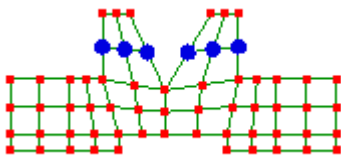

Select these nodes as viewed by clicking the X arrowhead



Right click on the selected nodes and select **Node coordinates**
Y 20

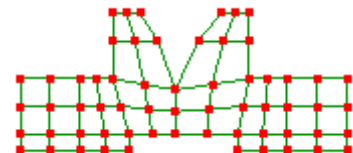

As some elements are disproportionately larger than the rest of the mesh, activate select elements 

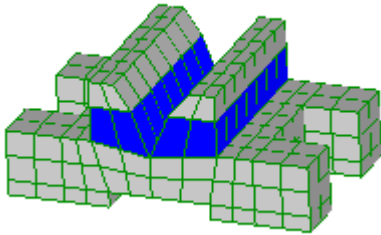

Select all these elements. Hold the **Ctrl** key down to add elements to the selection set, dynamically rotate and zoom-in to do this.

Mesh tools->Templates...

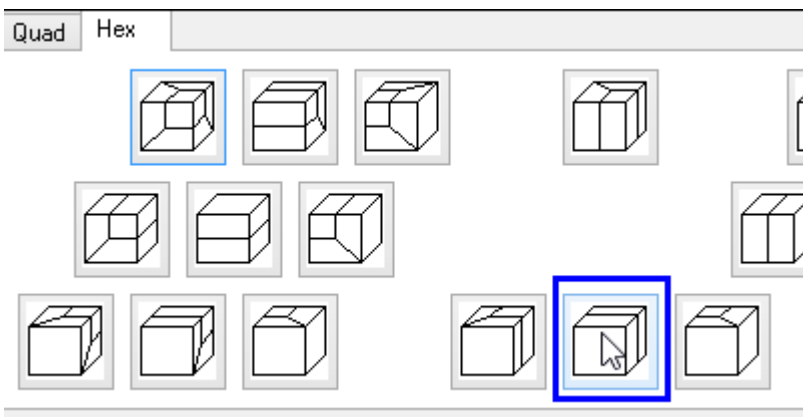

With 3D templates it might take a few attempts before getting the right one.

You can always **Ctrl+Z** to undo a wrong choice.

Again, if this template button doesn't split the elements as depicted, **Ctrl+Z** to undo and experiment with of the other similar patterns to get the mesh looking the same.

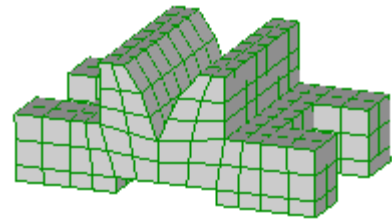

Step 11

 Activate select elements

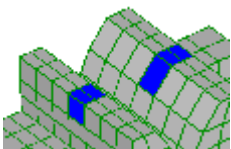

Hold the **Ctrl** key down and select the following elements. Then press the **delete** key.

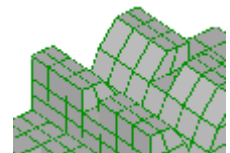

Deleting a single element creates a cut-out 5 wide, but the cut-out needs to be 10 wide. You have to move the nodes to get it to the right size for the cut-out.

Step 12



Click the Z arrowhead to view the model parallel to the screen.

Activate select nodes 

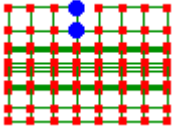

Select these nodes. Select this node **Mesh tools->Move/copy...**
X -2.5
Copy deselected

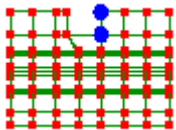

Select these nodes. Select this node **Mesh tools->Move/copy...**
X 2.5
Copy deselected

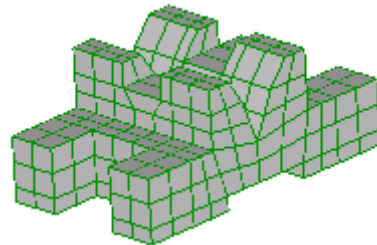

Step 13

Activate select nodes 



Click the Z arrowhead to view the model parallel to the screen.

Select all the nodes along this face **Mesh tools->Rotate/copy...**

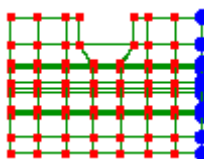

Rotation about point
X 35
Y 0
Z 0
Specify rotation angles around X, Y, Z axis in degrees
 0
 0
 6

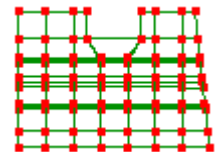

Select all the nodes along this face **Mesh tools->Rotate/copy...**

Rotation about point

X 0

Y 0

Z 0

Specify rotation angles around X, Y, Z axis in degrees

0

0

-6

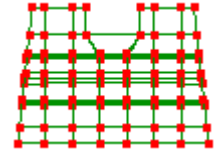
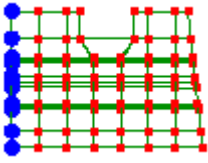

Step 14

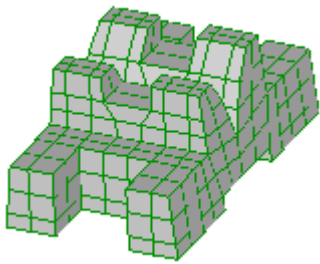

As this is a coarse mesh use the **Mesh tools->Refine->x2** to refine the mesh further.

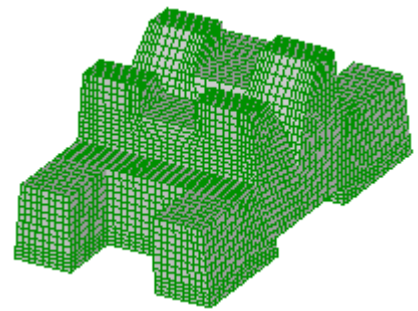

4.2 Rib, counter-bore and rounds

Step 1

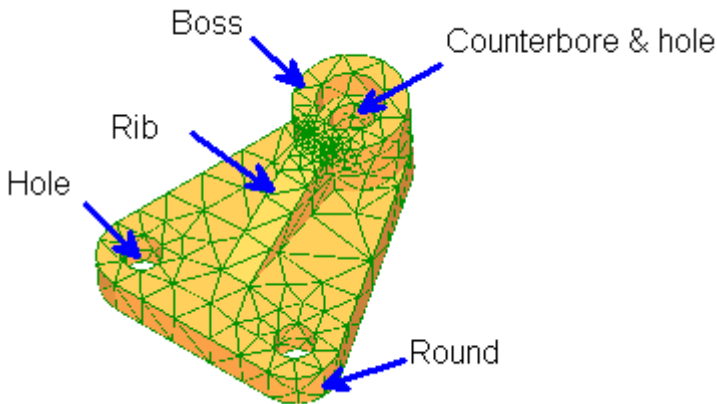

Identify the most difficult features and model them before the easier features.

In this model the holes and rounds are the most difficult, so these will be modeled first.

Step 2

You will use the mirror symmetry of the part to initially model some features which will be mirrored and then the rest of the model will be completed.



Click the Z arrowhead to view the model parallel to the screen.

Mesh tools->Create->Curve generator...



Center X	112
Center Y	32
Center Z	0
Start Point X	112
Start Point Y	0
Start Point Z	0
End Point X	144
End Point Y	32
End Point Z	0
Number of Nodes	6

Click OK to return to the curve generator dialog. Notice that the data has been converted into a trigonometric expression for the curve. Click OK.

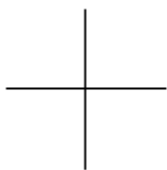

View->Fit to window

Step 3

Mesh tools->Create->Curve generator...



D1 30
D2 30

Click OK to exit the ellipse dialog but don't exit the curve generator dialog just yet. Change the $X = 15*\cos(p)$ into $X = 112+ 15*\cos(p)$ and the $Y = 15*\sin(p)$ into $Y = 32 +15*\sin(p)$, this will move the circle up by 32 where we would like it to be positioned. Change the **Number of elements** to 16. Now, click OK to exit the curve generator dialog.

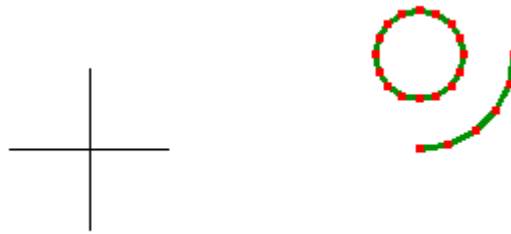

Step 4

Mesh tools->Create->Curve generator...



X1 0
Y1 0
Z1 0
X2 112
Y2 0
Z2 0
Number of nodes 6

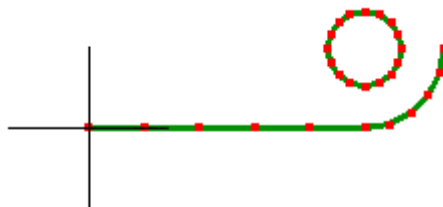

Step 5

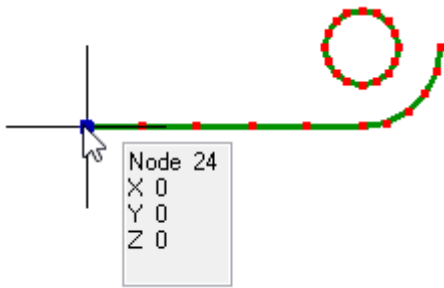

Click this node to obtain its node number which you will need for the mirror command.

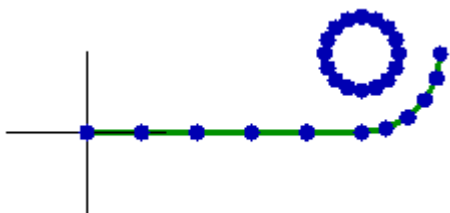

Select the entire mesh then **Mesh tools->Mirror/Copy...**
Mirror plane YZ plane
Mirror point
Node number 24
Copy selected

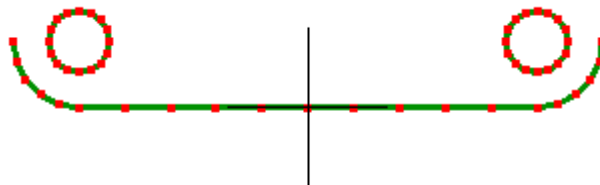

Step 6

Mesh tools->Create->Curve generator...



D1 82
D2 82

Click OK to exit the ellipse dialog but don't exit the curve generator dialog.
Change the $Y = 41*\sin(p)$ into $Y = 192 + 41*\sin(p)$, this will move the circle up by 192. Change the **Number of elements** to 32. Now, click OK to exit the curve generator dialog.

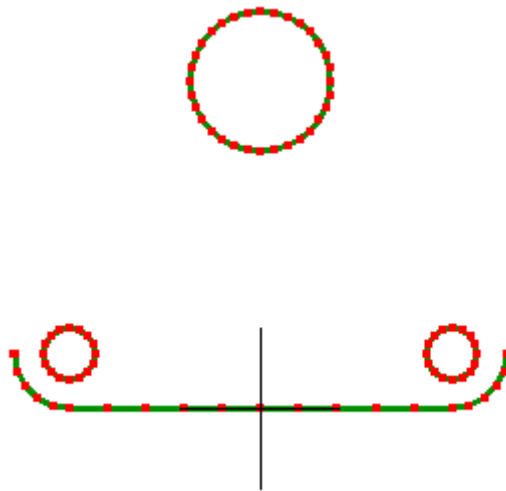

Repeat for:

D1 50
D2 50

Change the $Y = 25*\sin(p)$ into $Y = 192 + 25*\sin(p)$ and **Number of elements** to 16

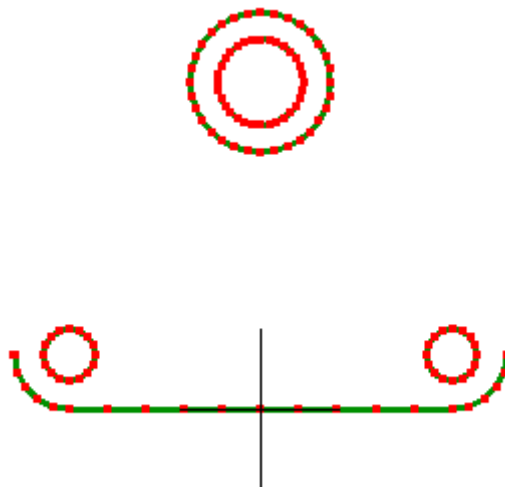

Repeat for:

D1 34
D2 34

Change the $Y = 17 \cdot \sin(p)$ into $Y = 192 + 17 \cdot \sin(p)$ and **Number of elements** to 16

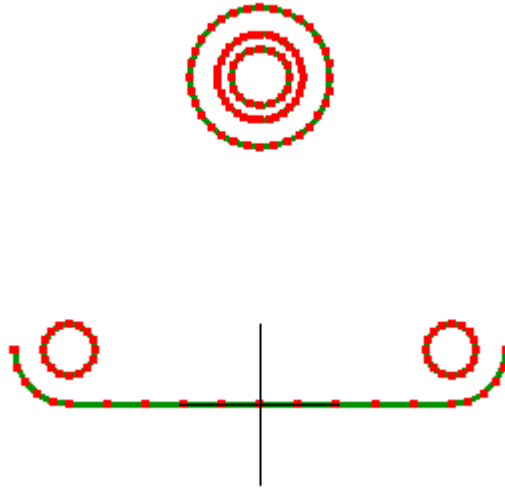

Step 7

The joint of the boss and the rib complicates creating the rib due to the curvature of the boss. To isolate the region of the rib in contact with the boss, a small rectangle with one side curved will be created.

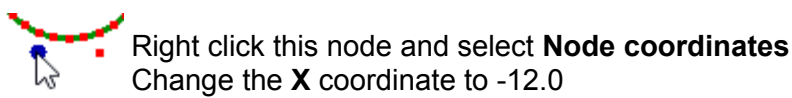
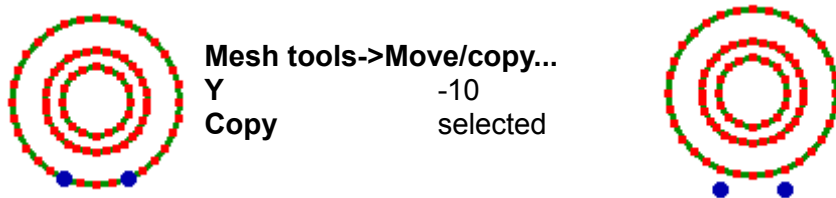
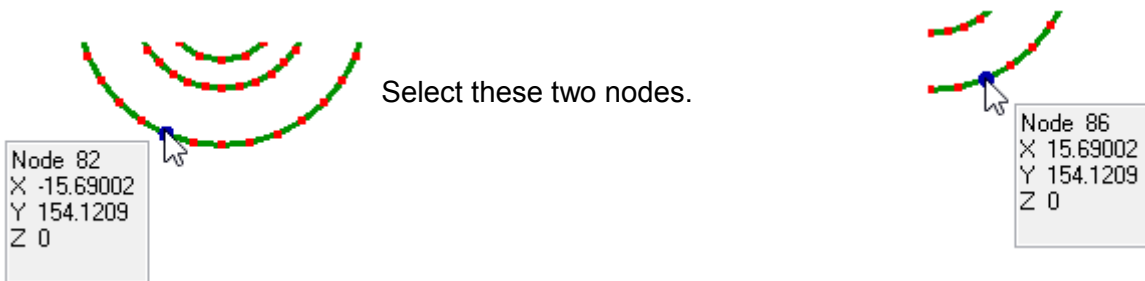



Right click this node and select **Node coordinates**
Change the **X** coordinate to 12.0

The reason for moving these nodes is because the width of the rib is 24.0.

Step 8



Select both nodes **Mesh tools->Move/copy...**
Y -92.121
Copy selected



This will be the bottom profile of the rib.



Select these two nodes and use the **Mesh tools-> Insert node between**



Repeat the command to get evenly spaced nodes as shown.



Step 9

These arcs have to be extended so that a line can be created to be tangential to the rounds and the raised boss.

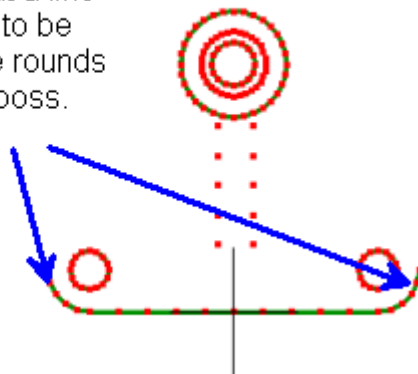

Mesh tools->Create->Curve generator...



Center X	112
Center Y	32
Center Z	0
Start Point X	144
Start Point Y	32
Start Point Z	0
End Point X	112
End Point Y	64
End Point Z	0
Number of Nodes	6

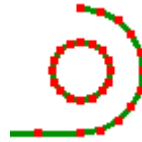

Repeat for:

Center X	-112
Center Y	32
Center Z	0
Start Point X	-112
Start Point Y	64
Start Point Z	0
End Point X	-144
End Point Y	32
End Point Z	0
Number of Nodes	6

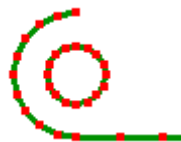

Step 10

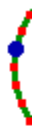

Select these two nodes and use the **Mesh tools->Insert node between**

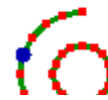

 Use this tool repeatedly to obtain this pattern.

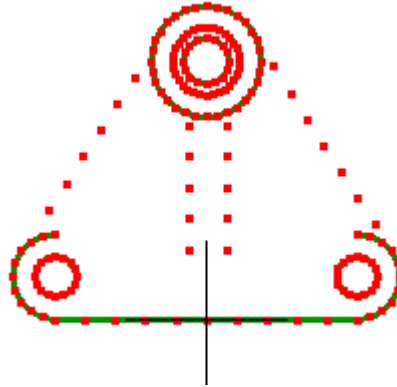

Step 11

 Activate select elements

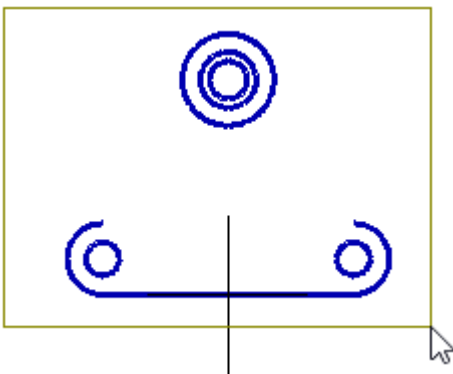

Drag to select the entire mesh. **Edit->Delete elements and retain nodes**

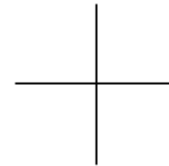

Activate select nodes 

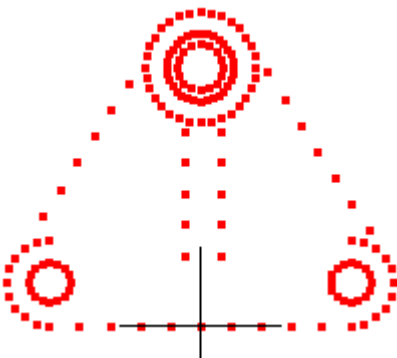

What we have left are just the nodes. We will use these nodes to lay out a coarse mesh from which the rest of the mesh will be built.

Step 12

Mesh tools->Create->Element...
quad4 shell

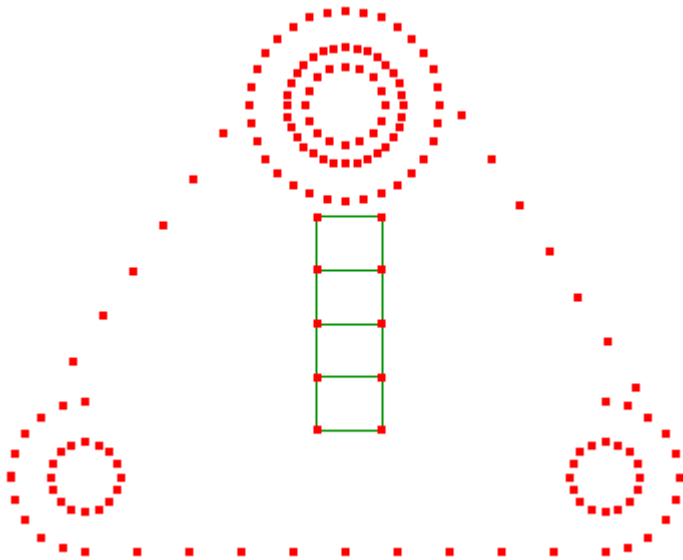

Click the nodes to form quadrilaterals. Do this going counter-clockwise starting from the lower left corner. This is only so that the particular template button used in step 13 will have the same result on your mesh.

Don't worry about the lack of symmetry in the mesh lay-out, it will be refined in the end and everything will be fine.

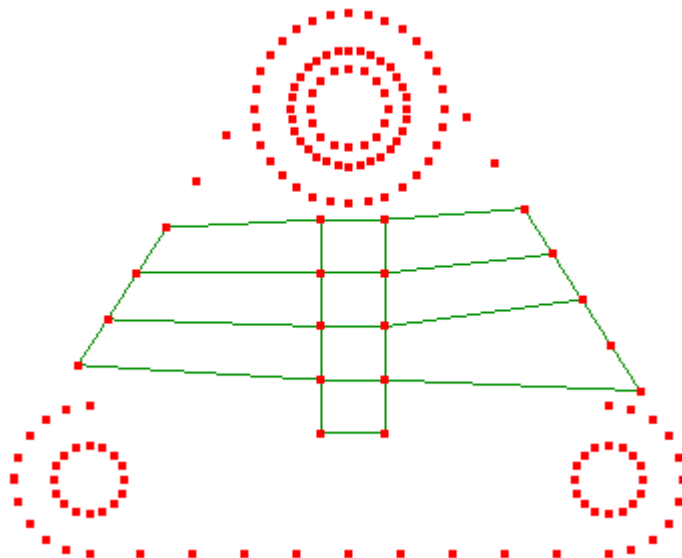

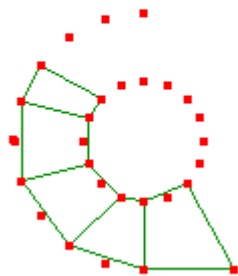
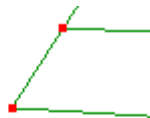
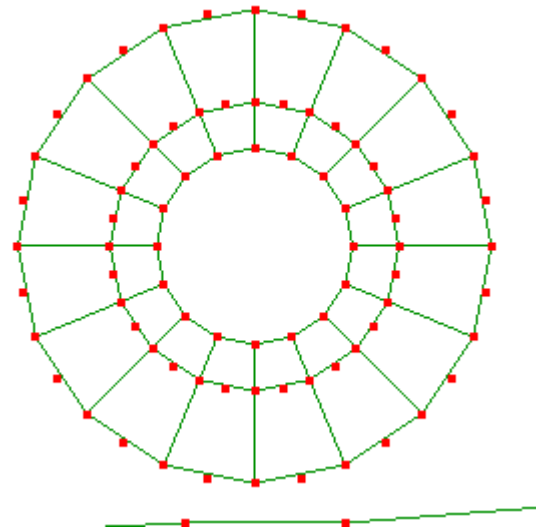
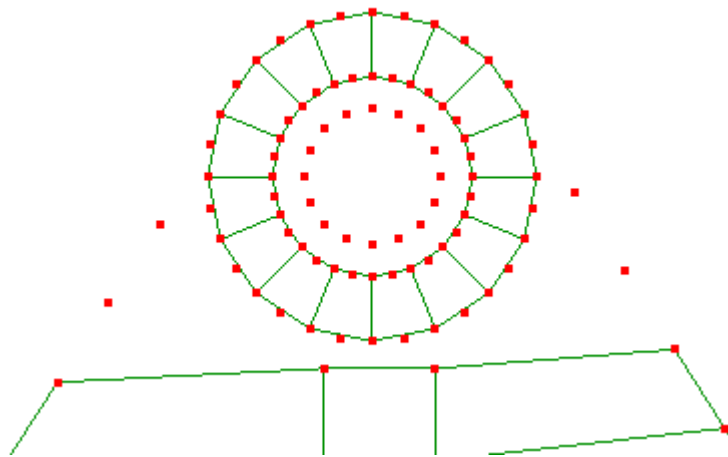

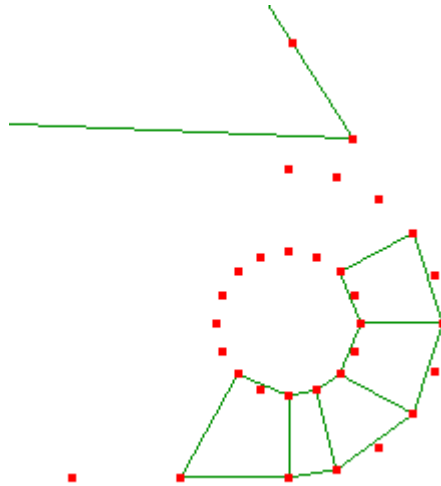

Step 13

To make the elements about the same size as each other, use the **Mesh tools->Templates...**

Activate select faces 

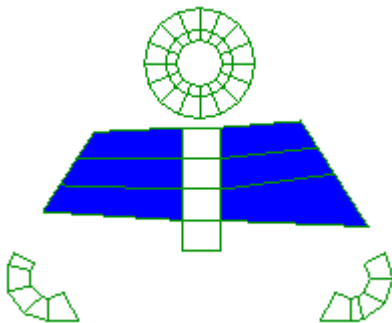

Select all these faces. Hold the **Ctrl** key down to add to or remove from the faces that have already been selected.

Then use this template.

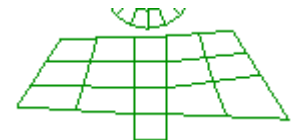

The action of the template depends on the order in which you clicked the nodes while creating it. So if it does not look the same as this, undo. Then try another to get it to look the same.

Repeat the template over the same selection.

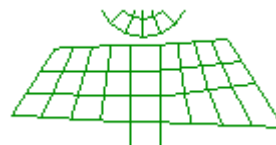

Step 14

Activate select nodes 

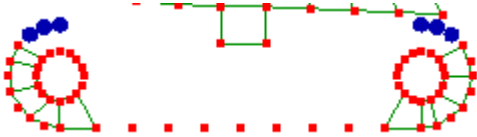

Select these nodes and press the **delete** key.

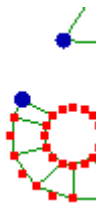
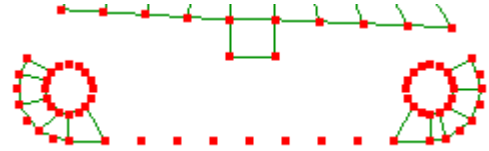

Select these two nodes and use the **Mesh tools-> Insert node between**

Repeat for the other side too.

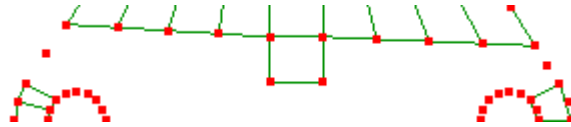

Step 15

Mesh tools->Create->Element...
quad4 shell

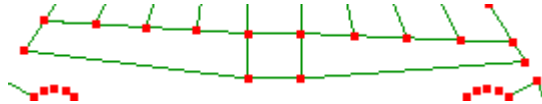

Step 16

Activate select faces 

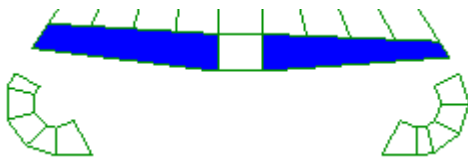

Select these two faces.

Mesh tools-> Refine ->Custom...

R 4
S 1
T 1

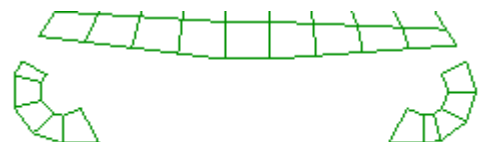

Step 17

Activate select faces 

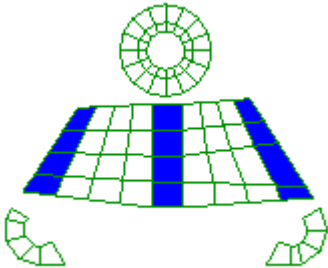

Mesh tools->Templates...

Select all these faces. Hold the **Ctrl** key down to add to or remove from the faces that have already been selected.

Then use this template.

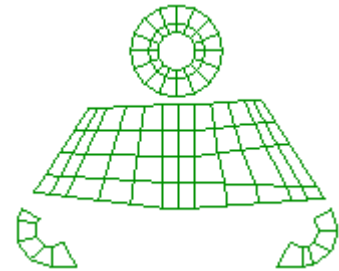

Step 18

Activate select nodes 

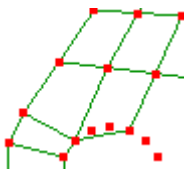

Mesh tools->Create->Element...
quad4 shell

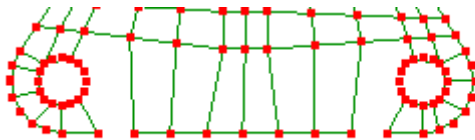
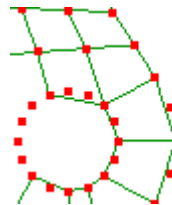

Step 19

Activate select faces 

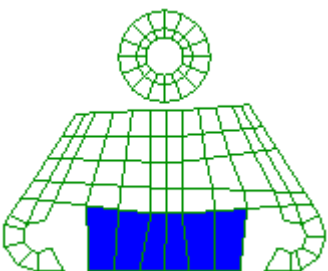

Mesh tools->Templates...

Select all these faces. Hold the **Ctrl** key down to add to or remove from the faces that have already been selected.

Then use this template.

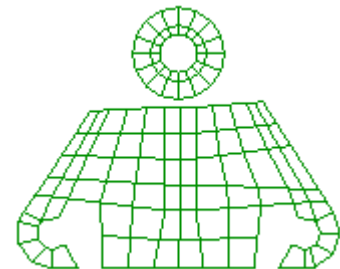

Step 20

Activate select nodes 

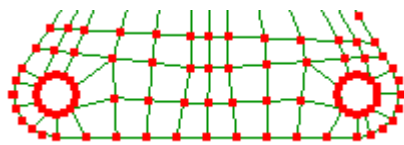
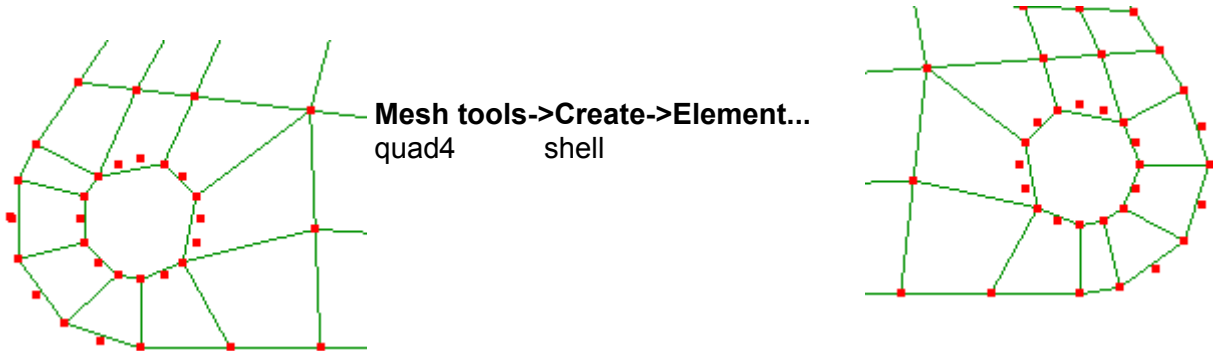

The bottom rounds now have a coarse mesh. Now you will focus on finishing the mesh at the boss.

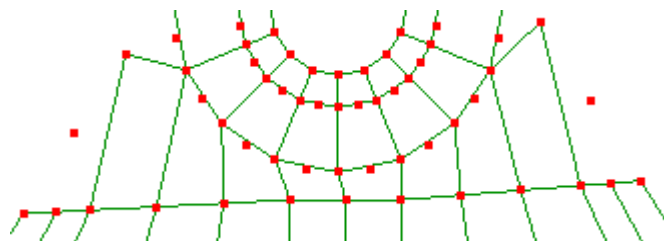

Change the element type from quad4 to tri3, the triangle element and complete the coarse mesh at the boss.

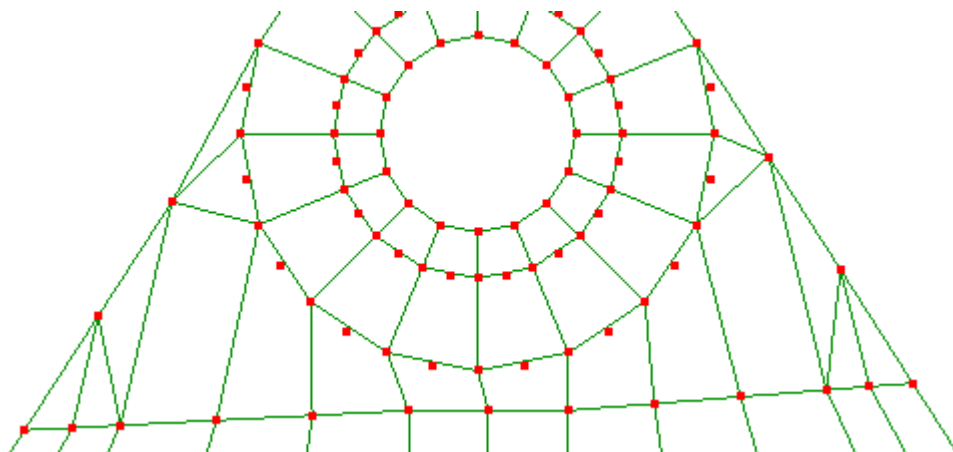

When extruded, the triangle elements will form pyramid solids and the quadrilateral elements will form hexahedrons.

Step 21

The **View->Open cracks** shows that the elements are not all connected. There are also a lot of unused nodes which need to be deleted. Exit open cracks mode to return to the normal editing mode.

Use the **Mesh tools->Erase unused nodes**.

Next, use the **Mesh tools->Merge nearby nodes** with a **Distance tolerance** of 0.001 to eliminate the duplicate nodes created during the meshing operations.

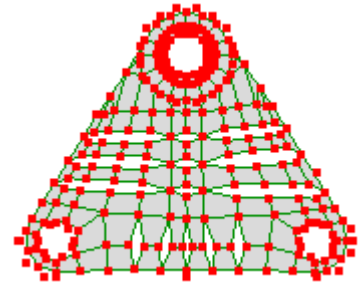

Step 22

Activate select faces 

Select the entire mesh.

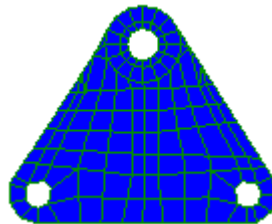

Mesh tools->Extrude...

Direction +Z
Thickness 30
Number of subdivisions 1

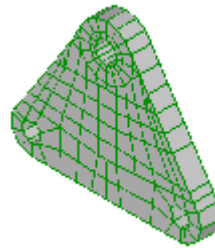

Step 23

Activate select faces 

Select the following faces

Note that the two elements between the boss and rib have been selected.

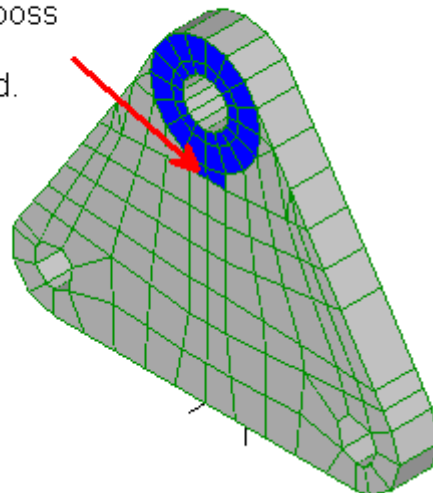

Mesh tools->Extrude...

Direction

+Z

Thickness

24

Number of subdivisions

1

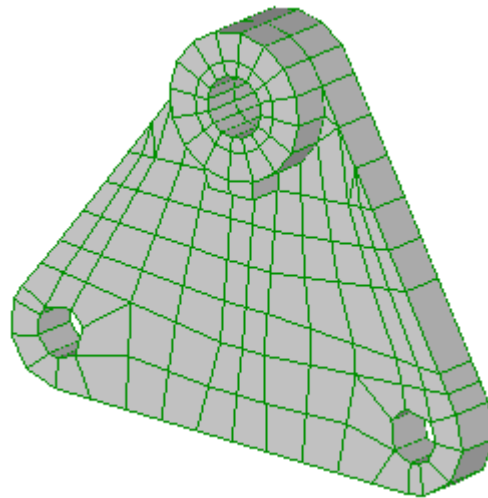

Step 24

Activate select faces 

Select the following faces

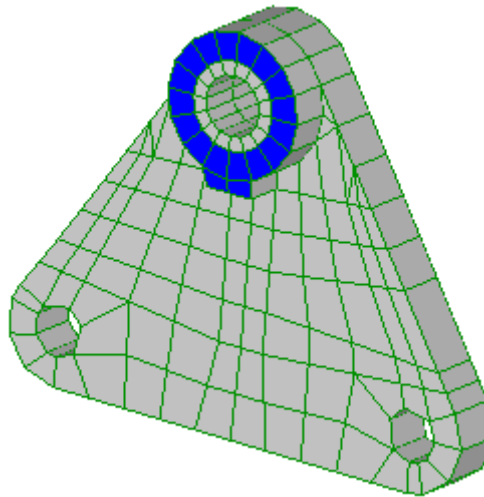

Mesh tools->Extrude...

Direction

+Z

Thickness

26

Number of subdivisions

1

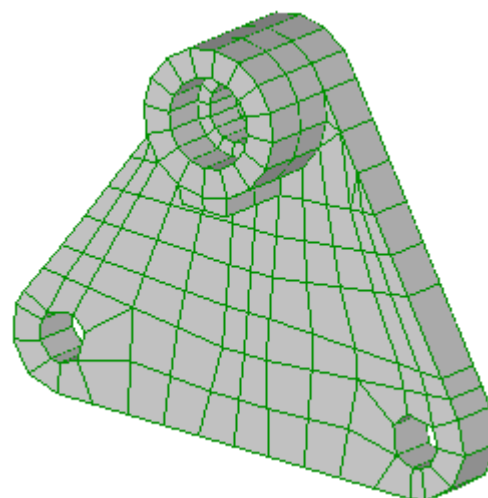

Step 25

Activate select nodes 

Select the two nodes that form the end points of the rib and do a **Mesh tools-> Insert node between**

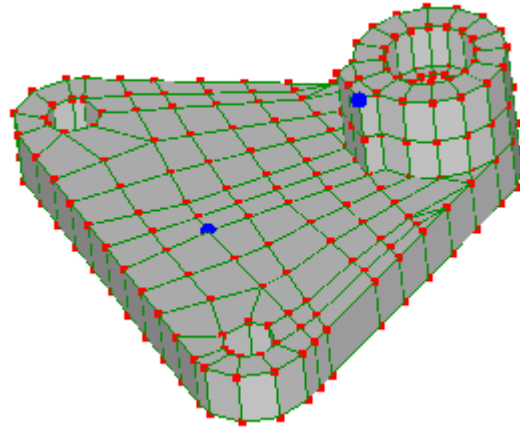

Repeat the command so that there are three nodes between the rib ends.

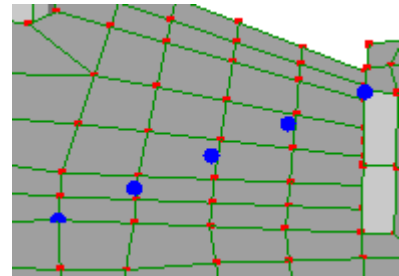

Step 26

Activate select nodes 

Mesh tools->Create->Element...
quad4 shell

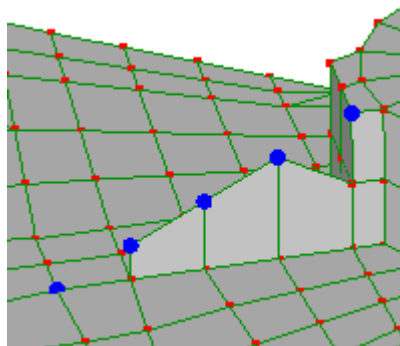

Switch the element type to tri3 and complete the rib profile.

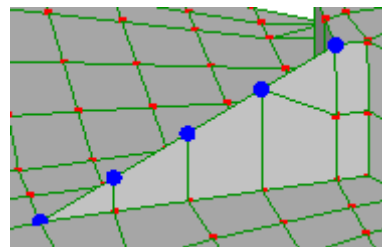

Step 27

Activate select faces 

Select the following faces.

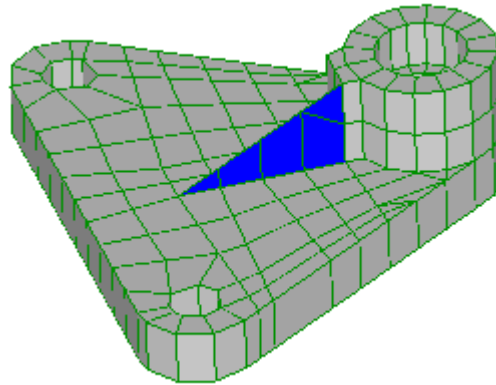

Mesh tools->Extrude...

Direction -X
Thickness 24
Number of subdivisions 2

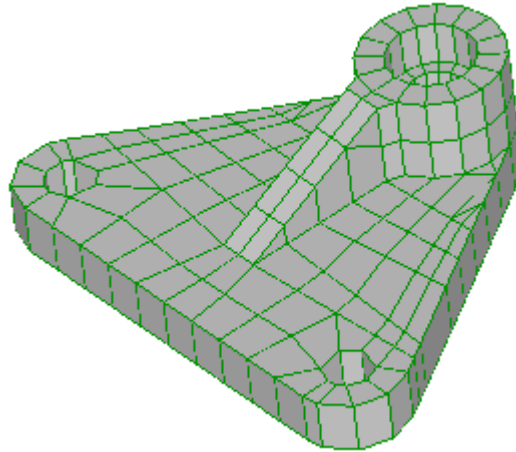

Step 28

As this is a coarse mesh use the **Mesh tools->Refine->x2** to refine the mesh further.

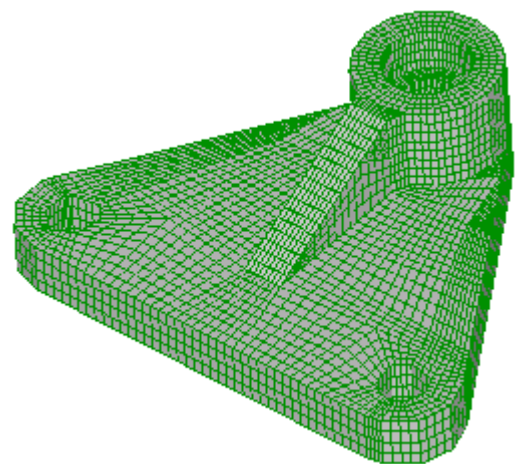

Step 29

The holes are faceted because the coarse mesh used very few nodes to form the circle.

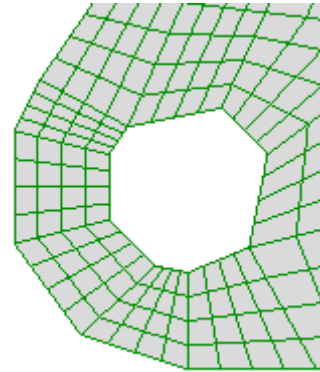

Click in the open space to deselect everything then activate select nodes 

Edit->Circle selection and drag to select the nodes of the hole.

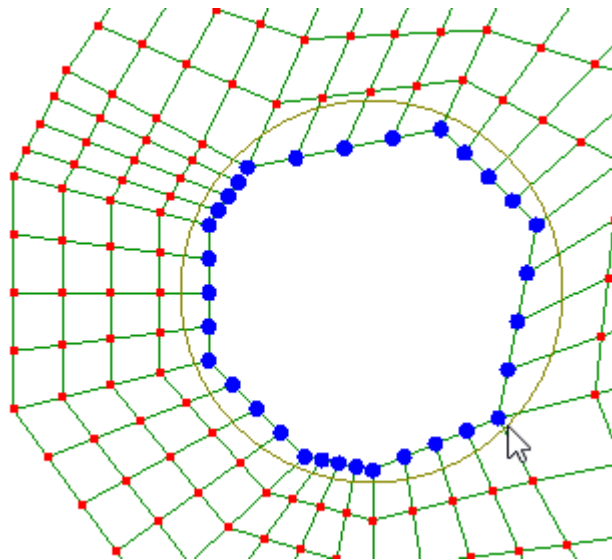

Mesh tools->Fit to sphere/cylinder/cone

Cylinder	select
Center	
X	-112
Y	32
Z	0
Radius	15
Axis	
Z	select

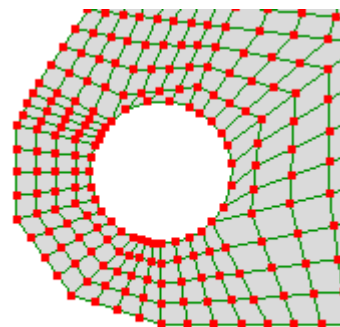

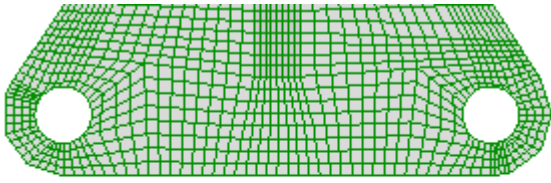

Repeat for the other faceted hole

Cylinder select
Center
X -112
Y 32
Z 0
Radius 15
Axis
Z select

Step 30

Click in the open space to deselect everything then activate select nodes 

Edit->Circle selection and drag to select the nodes of the hole.

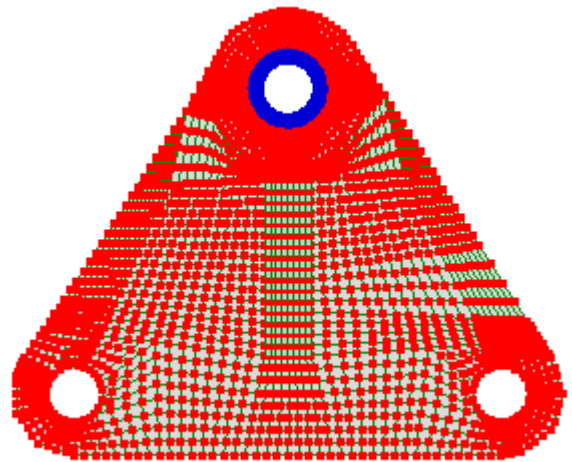

Mesh tools->Fit to sphere/cylinder/cone

Cylinder select
Center
X 0
Y 192
Z 0
Radius 17
Axis
Z select

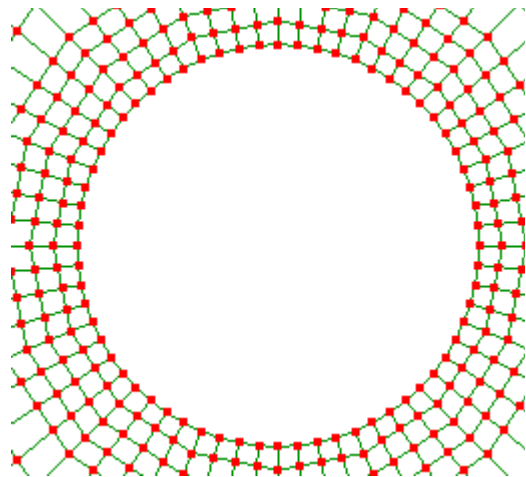

Step 31

Click in the open space to deselect everything then activate select nodes 

Edit->Circle selection and drag to select the nodes of the round.

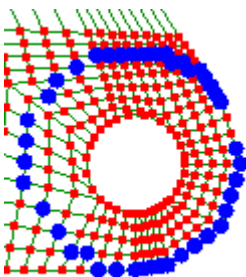
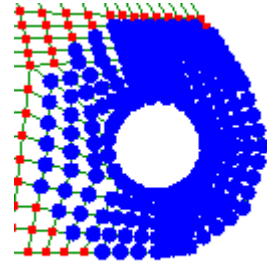

Hold the **Ctrl** key down and drag to deselect as many nodes inside of the round as possible.

To deselect the rest switch to **Edit->Rectangle selection** and drag a box over the blue nodes while holding the **Ctrl** key down. Drag, do not click, otherwise only the topmost nodes will be deselected while the remaining nodes behind it will continue to remain selected. Use the keyboard arrow keys to pan and page-up/down to zoom, otherwise you might click in open space and deselect everything.

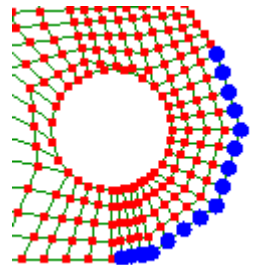

Mesh tools->Fit to sphere/cylinder/cone

Cylinder select
Center
X 112
Y 32
Z 0
Radius 32
Axis
Z select

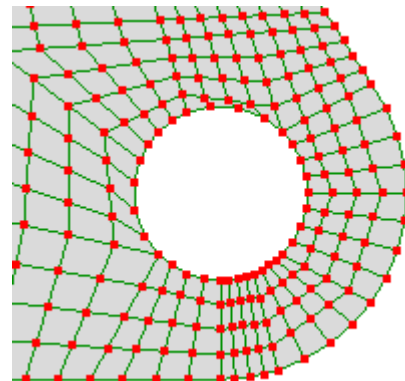

Repeat for the other round

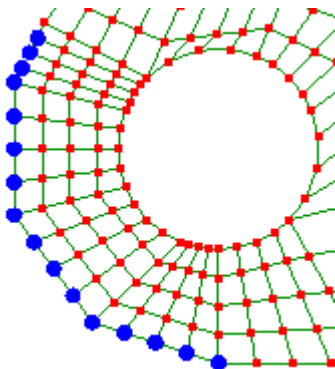

Mesh tools->Fit to sphere/cylinder/cone

Cylinderselect
Center
X -112
Y 32
Z 0
Radius 32
Axis
Z select

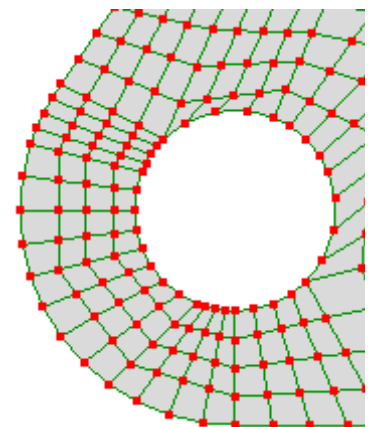

4.3 Intersecting holes and polygon shapes

Step 1

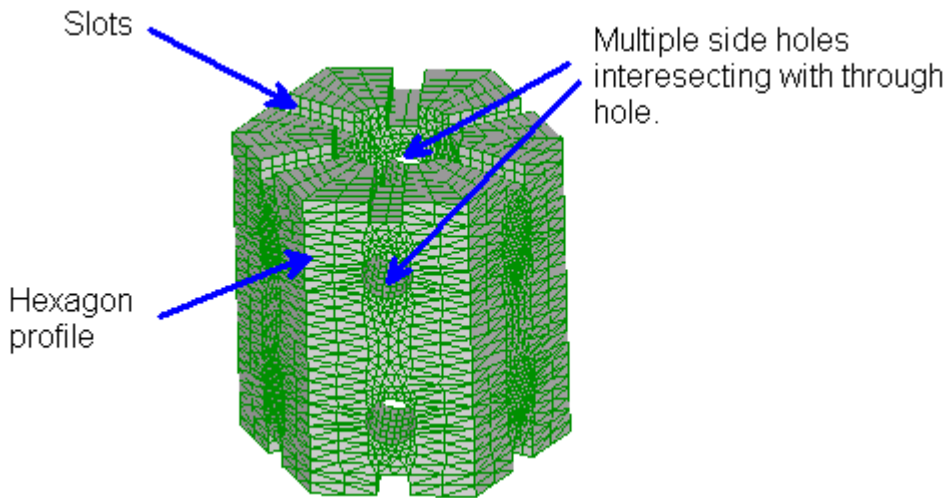

Identify the most difficult features and model them before the easier features.

In this model the side holes that intersect with the through hole are the most difficult, so this will be modeled first.

Step 2

Mesh tools->Create->Polyline...

Next node's coordinates:

X 12
Y 0
Z 0

Click the **Add** button

Change **Y** to 100 click **Add**
change **X** to -12 click **Add**
change **Y** to 0 click **Add**
click **Close shape**



Click the Z arrowhead to view the model parallel to the screen.

View->Fit to window

For now it has been modeled to a width of 24 but later it will be stretched to the actual width of 50. This was necessary because the left and right faces will be rotated in a later step and we didn't want them to penetrate other elements inside the mesh.

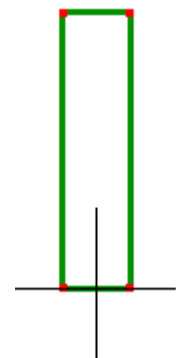

Step 3

Mesh tools->Create->Curve generator...



D1 16
D2 16

Click OK to exit the ellipse dialog but don't exit the curve generator dialog just yet.

Change the $Y = 8*\sin(p)$ into $Y = 25 + 8*\sin(p)$. This will move the circle up by 25 where we would like it to be positioned. Change the **Number of elements** to 12. Click OK to exit the curve generator dialog.

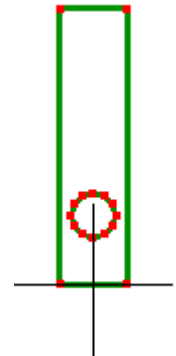

Step 4

Mesh tools->Create->Curve generator...



D1 16
D2 16

Click OK to exit the ellipse dialog but don't exit the curve generator dialog.

Change the $Y = 8*\sin(p)$ into $Y = 75 + 8*\sin(p)$, this will move the circle up by 25 where we would like it to be positioned. Change the **Number of elements** to 12. Click OK to exit the curve generator dialog.

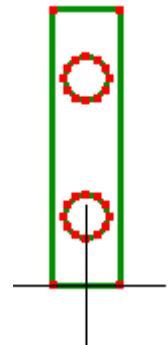

Step 5

You will be meshing this with the 2D automesh. But before doing so, you have to delete duplicate nodes created during the meshing operations using **Mesh tools->Merge nearby nodes** with a **Distance tolerance** of 0.001. Note the change in node numbers in the status bar after this command has been run.

Mesh tools->Automesh 2D...
Maximum element size 8

The automesher will briefly run in a separate window and then close.

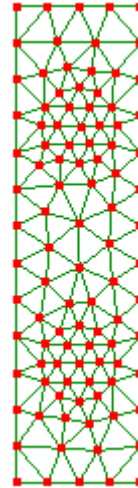

Step 6

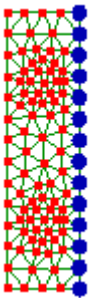

Select these nodes. Right click on the selected nodes and choose **Node coordinates** and enter 25 for the **X** coordinate.

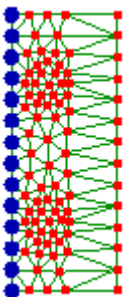

Select these nodes. Right click on the selected nodes and choose **Node coordinates** and enter -25 for the **X** coordinate.

The hexagon edge length has now been restored to 50. It had to be widened because those two faces will be rotated by 30 degrees later.

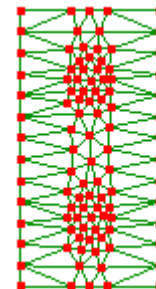

Step 7

Activate select nodes 

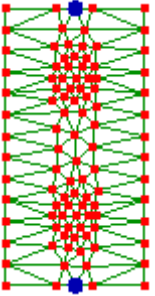

Select the following nodes and press the **delete** key. This is to prepare for the slot that will be done at a later step.

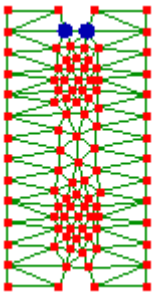
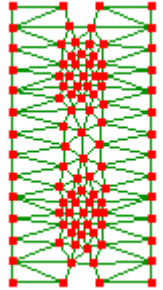

Select these nodes then right click on one of the selected nodes and choose **Node coordinates** and enter 93 for the **Y** coordinate.

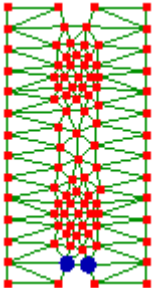

Likewise, select these nodes then right click on one of the selected nodes and choose **Node coordinates** and enter 7 for the **Y** coordinate.

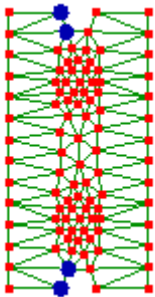

Select these nodes. Hold the **Ctrl** key while selecting them. Right click on one of the selected nodes and choose **Node coordinates** and enter -5 for the **X** coordinate.



Select these nodes. Hold the **Ctrl** key while selecting them. Right click on one of the selected nodes and choose **Node coordinates** and enter 5 for the **X** coordinate.

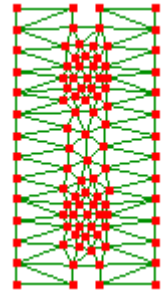

The mesh is now prepared for the 10×7 slot

Step 8

Mesh tools->Create->Element...
quad4 shell

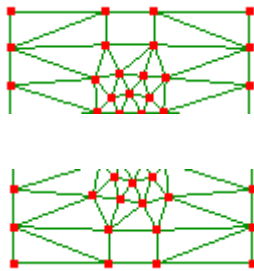

Click the nodes to form quadrilaterals.

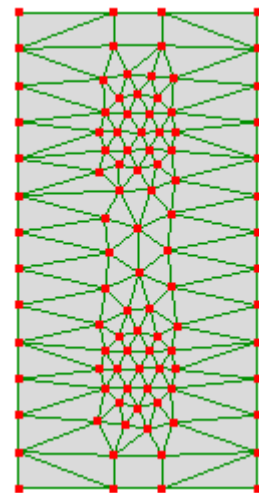

Step 9

Activate select faces 

Select the entire mesh.

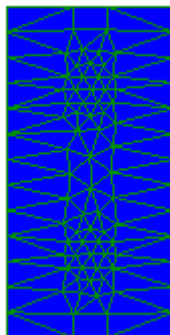

Mesh tools->Extrude...

Direction +Z
Thickness 23.3
Number of subdivisions 3

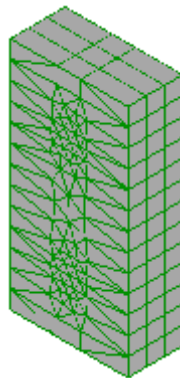

Step 10

Activate select nodes 

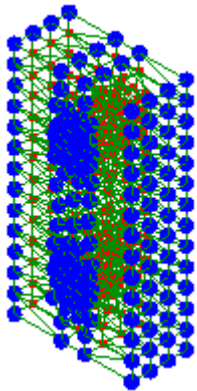

Select the entire mesh, **Mesh tools->Move/copy...**
Z 20

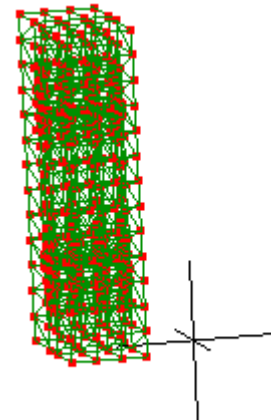

Step 11

Activate select nodes 



Node 392
X 25
Y 0
Z 43.3

We will be using this co-ordinate information to rotate the right hand face.



Click the Z arrowhead to view the model parallel to the screen.

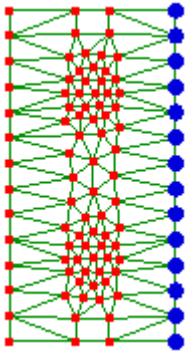

Select all the nodes on this face.

Mesh tools->Rotate/copy...

Rotation about point

X 25

Y 0

Z 43.3

Specify rotation angles around X, Y, Z in degrees

0

30

0

Make sure that the copy check-box is not selected.

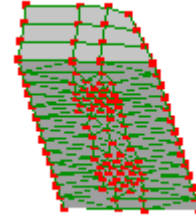

Step 12

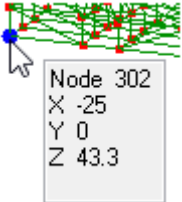

We will be using this co-ordinate information to rotate the left hand face.

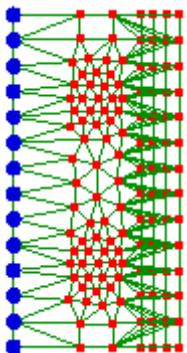

Select all the nodes on this face.

Mesh tools->Rotate/copy...

Rotation about point

X -25

Y 0

Z 43.3

Specify rotation angles around X, Y, Z in degrees

0

-30

0

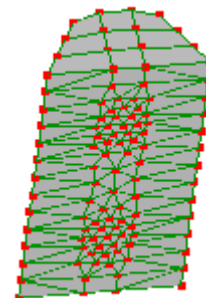

Step 13



Click the Y arrowhead to view the model parallel to the screen.

Activate select nodes 

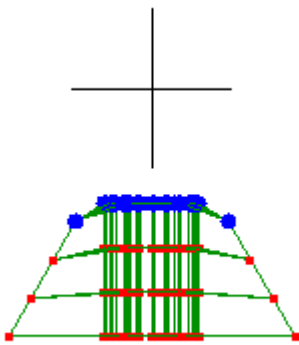

Select these nodes. **Mesh tools->Fit to sphere/cylinder/cone**

Cylinder select
Center
X 0
Y 0
Z 0
Radius 20
Axis
Y select

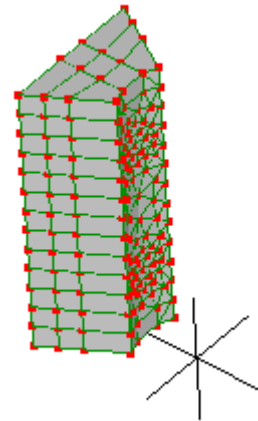

Step 14

Activate select nodes 

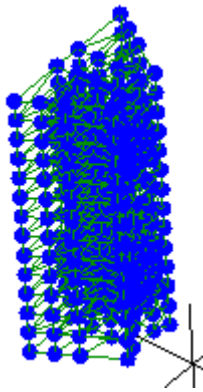

Select the entire model.

Mesh tools->Rotate/copy...

Rotation about point

X 0

Y 0

Z 0

Specify rotation angles around X, Y, Z in degrees

0

60

0

Copy selected

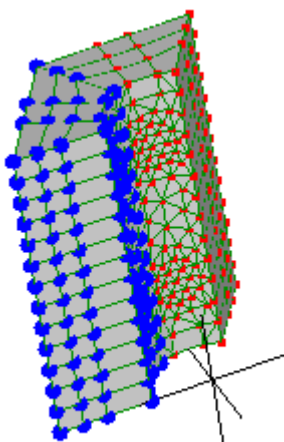

With the newly created elements selected, repeat the **Mesh tools->Rotate/copy...** with the same parameters and just click **Apply**.

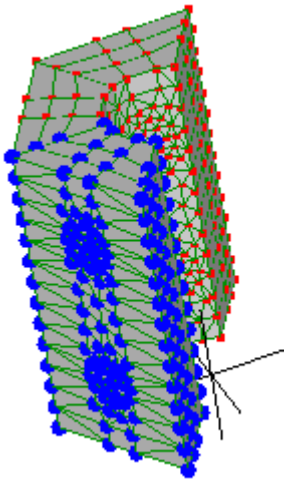

Once again with the newly created elements that are selected, repeat the **Mesh tools->Rotate/copy...**

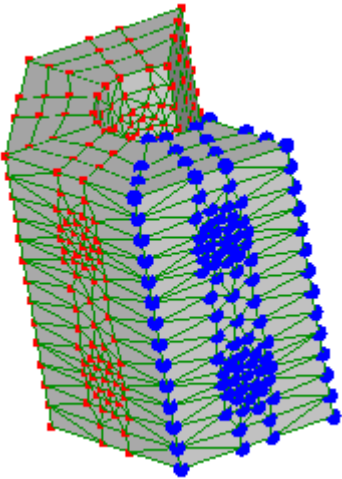

Do it again with the newly created elements that are selected. Repeat the **Mesh tools->Rotate/copy...**

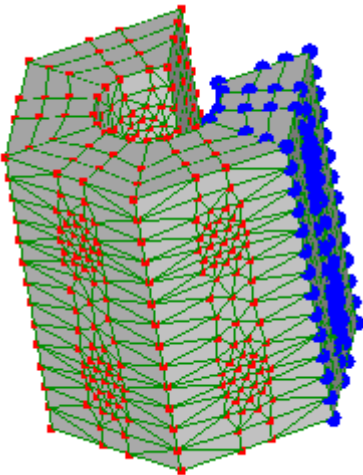

Once more for the final time.

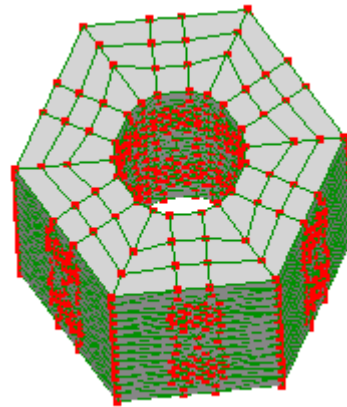

That completes the hexagonal shape. Now use the **Mesh tools->Merge nearby nodes** with a **Distance tolerance** of 0.01 to eliminate duplicate nodes created during the meshing operations. Note the change in node numbers in the status bar.

Step 15

Activate select nodes 



Click the Z arrowhead to view the model parallel to the screen.

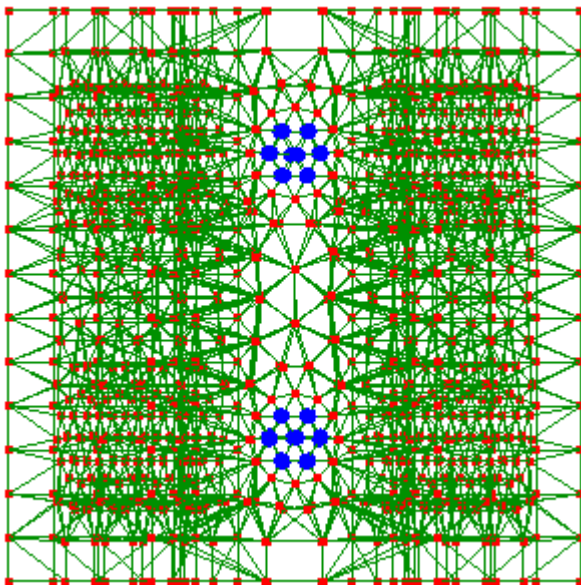

Edit->Circle selection and drag to select the nodes of the holes. Hold the **Ctrl** key to add to the node selection set. Also hold the **Shift** key to keep a node from moving if you happen to click on it.

Then press the **delete** key.

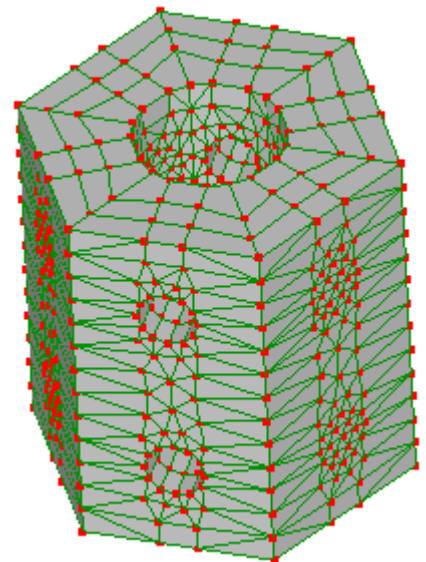

Step 16

 Activate select elements

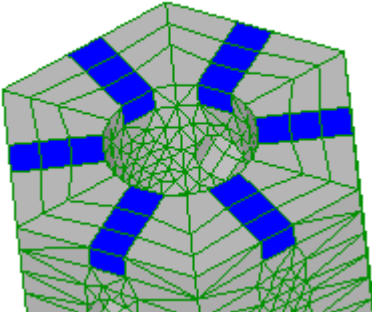

Select the elements where the slots are to be and press the **delete** key.

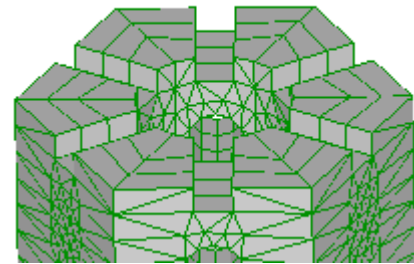

Step 17

 Activate select elements

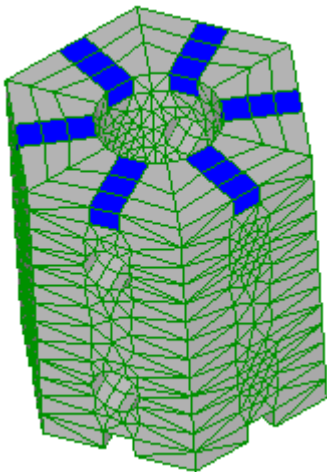

Similarly, rotate the model and select the elements where the slots are to be and press the **delete** key.

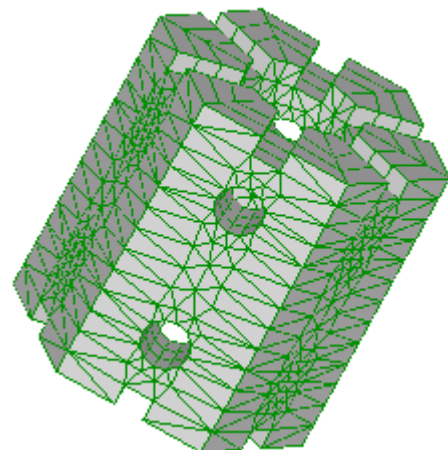

Step 18

As this is a coarse mesh use the **Mesh tools->Refine->x2** to refine the mesh further.

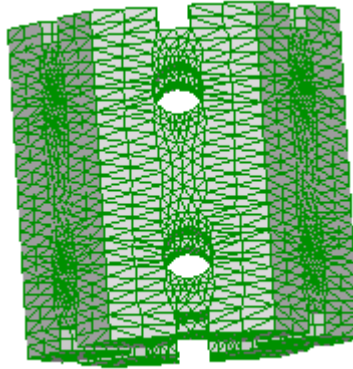

That concludes this *Beginners' Guide*. Hopefully you will now be quite familiar with LISA, and have confidence to modify the examples above and even build your own model from scratch. Additional skills, such as importing a CAD model, can be gained from the more advanced companion *LISA Tutorials and Reference Guide*.